

Portable Bluetooth Stereo Compact Disc Cassette Player with AM/FM Radio



**MODEL: CD-550BT
USER MANUAL**



**PLEASE READ THIS USER MANUAL COMPLETELY BEFORE OPERATING THIS UNIT
AND RETAIN THIS BOOKLET FOR FUTURE REFERENCE**

**Please contact Spectra Customer Service at 1-800-777-5331 if you have any questions
about operating this product**

A

WARNING

TO PREVENT FIRE OF SHOCK HAZARD, DO NOT USE THIS PLUG WITH AN EXTENSION CORD, RECEPTACLE OR OTHER OUTLET UNLESS THE BLADES CAN BE FULLY INSERTED TO PREVENT BLADE EXPOSURE. TO PREVENT FIRE OR SHOCK HAZARD, DO NOT EXPOSE THIS APPLIANCE TO RAIN OR MOISTURE.



The lightning flash with arrowhead symbol, within an equilateral triangle is intended to alert the user to the presence of uninsulated dangerous voltage within the product is enclosure that may be of sufficient magnitude to constitute a risk of electric shock to persons.

CAUTION
RISK OF ELECTRIC SHOCK
DO NOT OPEN

CAUTION TO REDUCE THE RISK OF ELECTRIC SHOCK, DO NOT REMOVE COVER (OR BACK). NO USER-SERVICEABLE PARTS INSIDE. REFER SERVICING TO QUALIFIED SERVICE PERSONNEL.



The exclamation point within an equilateral triangle is intended to alert the user to the presence of important operating and maintenance (servicing) instructions in the literature accompanying the appliance.

The Caution Marking is located at the bottom enclosure of the apparatus.
The Rating plate is located at the bottom enclosure of the apparatus.

IMPORTANT SAFETY INSTRUCTIONS

1. Read these instructions.
2. Keep these instructions.
3. Heed all warnings.
4. Follow all instructions.
5. Do not use this apparatus near water.
6. Clean only with dry cloth.
7. Do not block any ventilation openings. Install in accordance with the manufacturer's instructions.
8. Do not install near any heat sources such as radiators, heat registers, stoves, or other apparatus (including amplifiers) that product heat.
9. Do not defeat the safety purpose of the polarized or grounding-type plug. A polarized plug has two blades with one wider than the other. A grounding type plug has two blades and a third grounding prong. The wide blade or the third prong is provided for your safety. If the provided plug does not fit into your outlet, consult an electrician for replacement of the obsolete outlet.
10. Protect the power cord from being walked on or pinched particularly at plugs, convenience receptacles, and the point where they exit from the apparatus.
11. Only use attachments/accessories specified by the manufacturer.
12. Use only with a cart, stand, tripod, bracket, or table recommended by the manufacturer, or sold with the product. When a cart is used, use caution when moving the cart/apparatus combination to avoid injury from tip-over.
13. Unplug this apparatus during lightning storms or when unused for a long period of time.
14. Refer all servicing to qualified service personnel. Servicing is required when the apparatus has been damaged in any way, such as power-supply cord or plug is damaged, liquid has been spilled or objects have fallen into the apparatus, the apparatus has been exposed to rain or moisture, does not operate normally, or has been dropped.



15. This appliance shall not be exposed to dripping or splashing water and that no object filled with liquids such as vases shall be placed on the apparatus.
16. Do not overload wall outlet. Use only power source as indicated.
17. Use replacement part as specified by the manufacturer.
18. Upon completion of any service or repairs to this product, ask the service technician to perform safety checks.
19. Power Sources - This product should be operated only from the type of power source indicated on the marking label. If you are not sure of the type of power supply to your home, consult your product dealer or local power company. For products intended to operate from battery power, or other sources, refer to the operating instruction.
20. Object and Liquid Entry - Never push objects of any kind into this product through openings as they may touch dangerous voltage points or short-out parts that could result in a fire or electric shock. Never spill liquid of any kind on the product.
21. Damage Requiring Service - Unplug this product from the wall outlet and refer servicing to qualified service personnel under the following conditions:
 - a) When the power-supply cord or plug is damaged,
 - b) If liquid has been spilled, or objects have fallen into the product,
 - c) If the product has been exposed to rain or water,
 - d) If the product does not operate normally by following the operating instructions. Adjust only those controls that are covered by the operating instructions as an improper adjustment of other controls may result in damage and will often require extensive work by a qualified technician to restore the product to its normal operation.
 - e) If the product has been dropped or damaged in any way, and
 - f) When the product exhibits a distinct change in performance - this indicates a need for service.
22. Mains plug is used as disconnect device and it should remain readily operable during intended use. In order to disconnect the apparatus from the mains completely, the mains plug should be disconnected from the mains socket outlet completely.
23. Battery shall not be exposed to excessive heat such as sunshine, fire or the like.
24. Excessive sound pressure from earphones and headphone can cause hearing loss.
25. Minimum distances of 4 inches around the apparatus for sufficient ventilation.
26. The ventilation should not be impeded by covering the ventilation openings with items, such as newspapers, table-cloths, curtains, etc.
27. No open flame sources, such as lit candles, should be placed on the product.
28. The use of apparatus in moderate climates.
29. Attention should be drawn to the environmental aspects of battery disposal.

This symbol indicates that this product incorporates double insulation between hazardous mains voltage and user accessible parts.

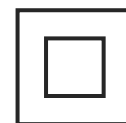

CAUTION:
 TO PREVENT ELECTRIC SHOCK, MATCH WIDE BLADE OF
 PLUG TO WIDE SLOT. FULLY INSERT THE PLUG TO MAIN
 POWER SOCKET.

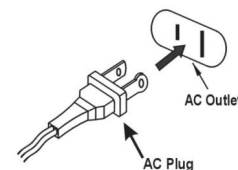

SAVE THESE INSTRUCTIONS

CAUTION

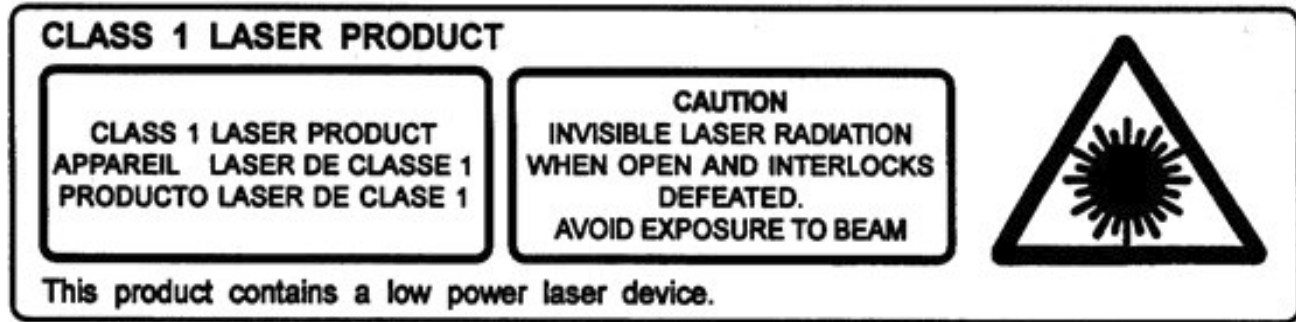

Follow the advice below for safe operations.

ON PROTECTION AGAINST LASER ENERGY EXPOSURE

- As the laser beam used in this compact disc player is harmful to the eyes, do not attempt to disassemble the casing.
- Stop operation immediately if any liquid or solid object should fall into the cabinet.
- Do not touch the lens or poke at it. If you do, you may damage the lens and the player may not operate properly.
- Do not put anything in the safety slot. If you do, the laser diode will be ON when the CD door is still open.
- If the unit is not to be used for a long period of time, make sure that all power sources are disconnected from the unit. Remove all batteries from the battery compartment.
- This unit employs a laser. The use of controls or adjustment or performance of procedures other than those specified here may result in exposure to hazardous radiation.

Should any trouble occur, remove the power source and refer servicing to qualified personnel.

COMPLIANCE WITH FCC REGULATIONS

FCC ID: 2AB4KMETYH525

This device complies with Part 15 of the FCC Rules. Operation is subject to the following two conditions:

- (1) This device may not cause harmful interference, and
- (2) This device must accept any interference received, including interference that may cause undesired operation.

This equipment has been tested and found to comply with the limits for a Class B Digital Device, pursuant to Part 15 of the FCC Rules. These limits are designed to provide reasonable protection against harmful interference in a residential installation. This equipment generates uses and can radiate radio frequency energy and, if not installed and used in accordance with the instructions, may cause harmful interference to radio communications. However, there is no guarantee that interference will not occur in a particular installation. If this equipment does cause harmful interference to radio or television reception, which can be determined by turning the equipment off and on, the user is encouraged to try to correct the interference by one or more of the following measures:

- Reorient or relocate the receiving antenna.
- Increase the separation between the equipment and receiver.
- Connect the equipment into an outlet on a circuit different from that to which the receiver is connected.
- Consult the dealer or an experienced radio/TV technician for help.

WARNING

Changes or modifications to this unit not expressly approved by the party responsible for compliance could void the user's authority to operate the equipment.

PROTECT YOUR FURNITURE

This system is equipped with non-skid rubber 'feet' to prevent the product from moving when you operate the controls. These 'feet' are made from non-migrating rubber material specially formulated to avoid leaving any marks or stains on your furniture. However certain types of oil based furniture polishes, wood preservatives, or cleaning sprays may cause the rubber 'feet' to soften, and leave marks or a rubber residue on the furniture.

To prevent any damage to your furniture we strongly recommend that you purchase small self-adhesive felt pads, available at hardware stores and home improvement centers everywhere and apply these pads to the bottom of the rubber 'feet' before you place the product on fine wooden furniture.

DEAR JENSEN® CUSTOMER

Selecting fine audio equipment such as the unit you've just purchased is only the start of your musical enjoyment. Now it's time to consider how you can maximize the fun and excitement your equipment offers. This manufacturer and the Electronic Industries Association's Consumer Electronics Group want you to get the most out of your equipment by playing it at a safe level. One that lets the sound come through loud and clear without annoying blaring or distortion and, most importantly, without affecting your sensitive hearing. Sound can be deceiving. Over time your hearing "comfort level" adapts to higher volumes of sound. So what sounds "normal" can actually be loud and harmful to your hearing. Guard against this by setting your equipment at a safe level BEFORE your hearing adapts.

To establish a safe level:

- Start your volume control at a low setting.
- Slowly increase the sound until you can hear it comfortably and clearly, and without distortion.
- Once you have established a comfortable sound level: Set the dial and leave it there.

Taking a minute to do this now will help to prevent hearing damage or loss in the future.

After all, we want you listening for a lifetime.

We Want You Listening For a Lifetime

Used wisely, your new sound equipment will provide a lifetime of fun and enjoyment. Since hearing damage from loud noise is often undetectable until it is too late, this manufacturer and the Electronic Industries Association's Consumer Electronics Group recommend you avoid prolonged exposure to excessive noise.



Customer's Record:

The serial number of this product is found on its bottom cover. You should note the serial number of this unit in the space provided as a permanent record of your purchase to aid in identification in the event of theft or loss.

Model Number: CD-550BT

Serial Number:

LOCATION OF CONTROLS

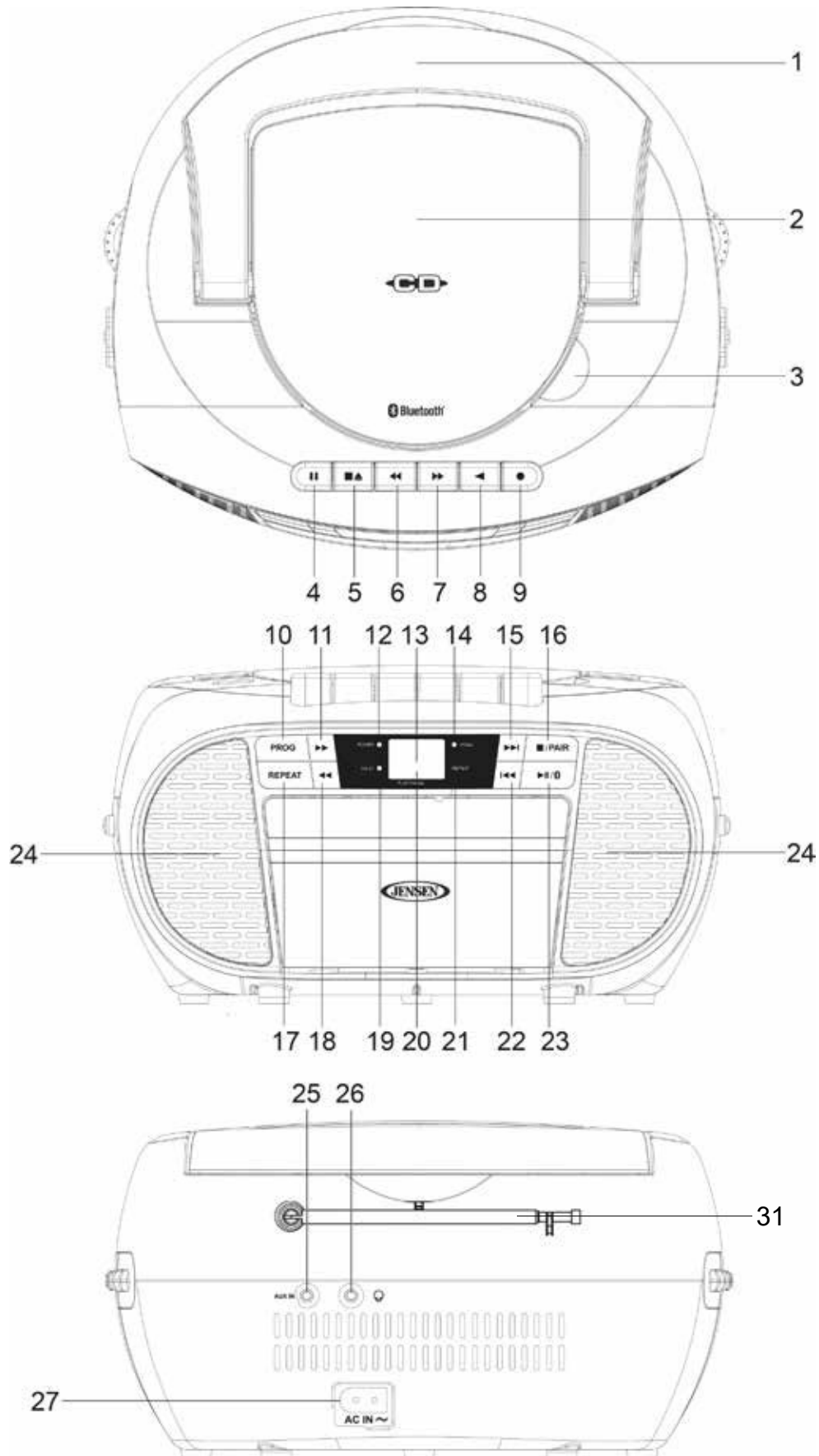

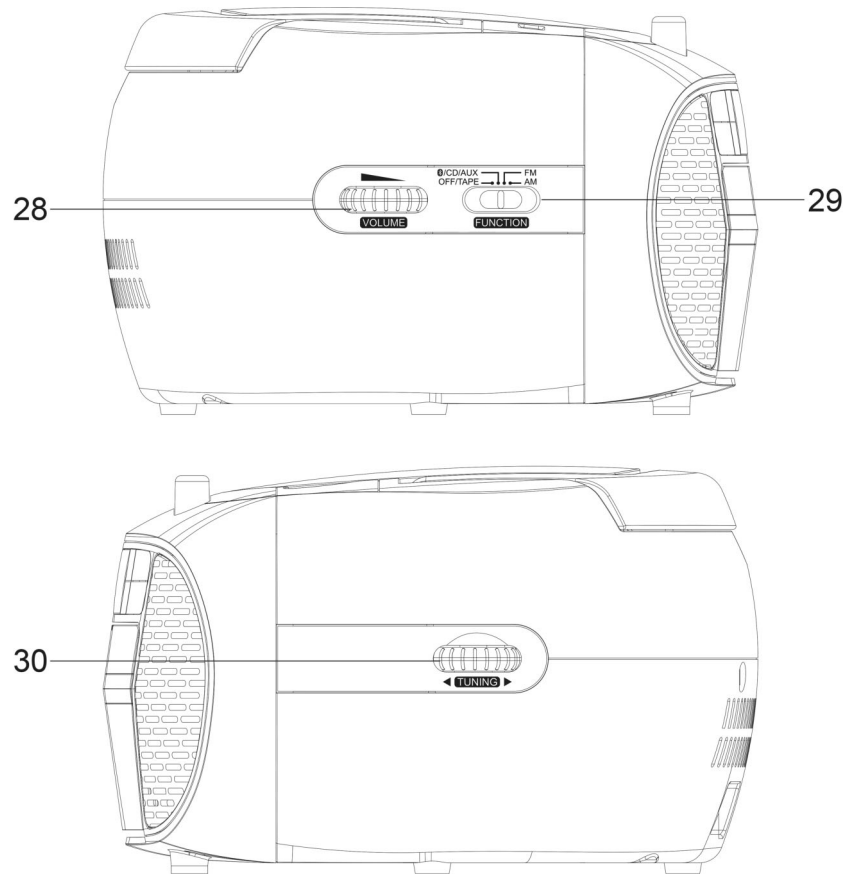

- | | |
|------------------------------------|--|
| 1. CARRYING HANDLE | 16. CD STOP ■ / BLUETOOTH PAIR BUTTON |
| 2. CD DOOR | 17. REPEAT BUTTON |
| 3. CD DOOR ACCESS POINT | 18. CD REWIND ◀◀ BUTTON |
| 4. CASSETTE PAUSE BUTTON | 19. FM STEREO INDICATOR |
| 5. CASSETTE STOP/EJECT ■ ▲ BUTTON | 20. PLAY/PAUSE INDICATOR |
| 6. CASSETTE FAST FORWARD ◀◀ BUTTON | 21. REPEAT INDICATOR |
| 7. CASSETTE REWIND ▶▶ BUTTON | 22. CD SKIP- ◀◀ BUTTON |
| 8. CASSETTE PLAY ◀ BUTTON | 23. CD PLAY/PAUSE ▶ / BLUETOOTH ℹ️ BUTTON |
| 9. CASSETTE RECORD ● BUTTON | 24. SPEAKERS |
| 10. PROGRAM BUTTON | 25. AUX IN JACK |
| 11. CD FAST FORWARD ▶▶ BUTTON | 26. HEADPHONE JACK |
| 12. POWER INDICATOR | 27. AC POWER JACK |
| 13. LED DISPLAY | 28. VOLUME CONTROL |
| 14. PROGRAM INDICATOR | 29. FUNCTION SELECTOR (AM /FM / TAPE (OFF) / ℹ️ /CD/AUX) |
| 15. CD SKIP+ ▶▶ BUTTON | 30. TUNING CONTROL |
| | 31. TELESCOPIC ANTENNA |

POWER SOURCES

This unit operates on 120V~ 60Hz or 6 x DC1.5V “C” (UM-2) batteries. Do not attempt to operate the unit on any other power source. You could cause damage to the unit and void your warranty. Please be sure the power outlet you plug this unit into is working and receives constant (unswitched) power.

AC OPERATION

Plug the detachable AC cord into a standard AC outlet (120V~60Hz).

1. When the AC power cord (included) is connected to the AC POWER JACK (#27) on the back of the unit and the other end is plugged into a 120V AC~ 60Hz wall outlet, the unit will disconnect the batteries automatically, and operate on AC Power only.
2. Slide the FUNCTION SELECTOR (#29) to “0/CD/AUX” position for BLUETOOTH/CD/AUX play, “FM” for FM radio, “AM” for AM radio and “OFF/TAPE” for cassette recorder play or unit power off.

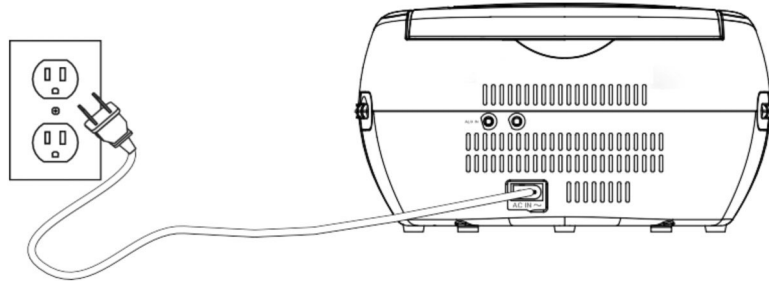

WARNING:

- Before connecting to the power outlet, ensure that the outlet corresponds to the information on the rating label at the bottom of the apparatus.

BATTERY OPERATION

1. Remove the BATTERY DOOR on the bottom of the unit.
2. Install 6 x DC1.5V “C” (UM - 2) batteries (not included) according to the polarity diagram inside the battery compartment.
3. Close the BATTERY DOOR

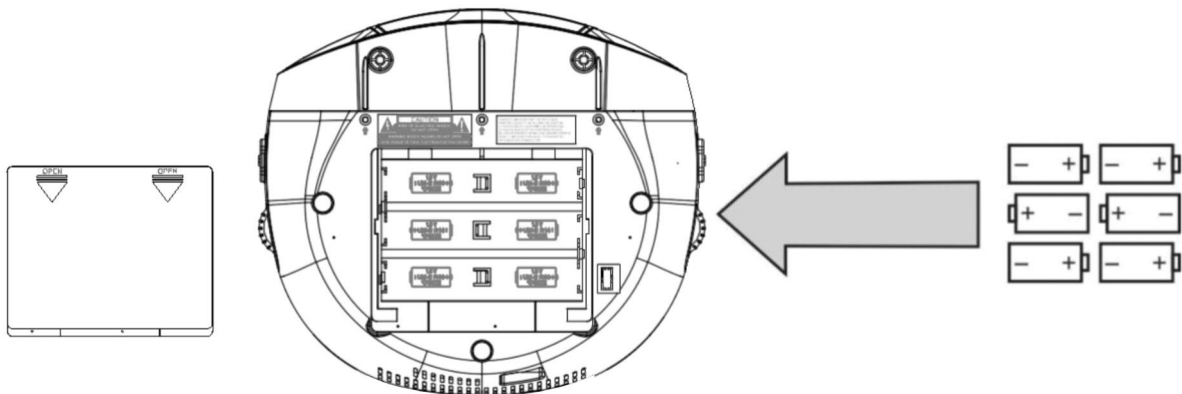

IMPORTANT: Be sure that the batteries are installed correctly. Wrong polarity may damage the unit and void the warranty.



BATTERY NOTE AND CARE

1. Danger of explosion if the battery is replaced incorrectly. Replace only with the same or equivalent type
2. Do not mix old and new batteries.
3. Do not mix alkaline, standard (carbon-zinc) or rechargeable (nickel-cadmium) batteries.
4. If the unit is not to be used for an extended period of time, remove the batteries. Old or leaking batteries can cause damage to the unit and may void the warranty.
5. Do not try to recharge batteries not intended to be recharged; they can overheat and rupture. (Follow battery manufacturer's directions).
6. Do not dispose of batteries in fire, batteries may leak or explode.

BATTERY REPLACEMENT

When the output sound of this unit becomes distorted or the CD player operation appears unstable, the batteries are weak. You need to replace all the exhausted batteries at the same time as soon as possible to avoid battery leakage.

RADIO OPERATION

1. Slide the FUNCTION SELECTOR (#29) to AM or FM position.
2. Rotate the TUNING CONTROL (#30) to your desired radio station according to the dial scale on the knob.
3. Rotate the VOLUME CONTROL (#28) to adjust to the desired output level.
4. To turn off the radio, slide the FUNCTION SELECTOR (#29) to OFF/TAPE position.

TIPS FOR BEST RECEPTION

AM – The AM antenna is located inside the cabinet of the unit. If AM reception is weak, change the position of unit until the internal antenna picks up the strongest signal.

FM – If a stereo broadcast program is being received, the FM STEREO INDICATOR (#18) will light. During FM or FM Stereo reception, always keep the FM TELESCOPIC ANTENNA (#31) fully extended for best performance. However, if FM reception is weak, try repositioning the unit near an open window until you get the best reception.





CD OPERATION

PLEASE READ THIS IMPORTANT INFORMATION:

CD mechanisms used in devices like this are designed to fully read all commercial CDs. They will also read self-compiled CD-R/CD-RW discs but it may take up to 10 seconds for playback to start. If playback does not start, it is likely due to the quality of the CD-R/RW disc and/or the compatibility of the CD compilation software. Manufacturer is not responsible for the playback quality of CD-R/RW discs.

Do not attach a label or seal to either side of the CD-R/RW disc. It may cause a malfunction.

PLAY MODE

1. Slide the FUNCTION SELECTOR (#29) to the /CD/AUX position.
2. Open the CD DOOR (#2), load a CD with the label side facing upward and then close the CD door (#2).
3. Disc information (total number of tracks) will appear on the LED DISPLAY (#13).
4. Press CD PLAY/PAUSE  BUTTON (#23) to start playing the CD; the PLAY/PAUSE INDICATOR (#20) will light steadily.
5. While playing, press the PLAY/PAUSE  BUTTON (#23) to pause, the PLAY/PAUSE INDICATOR (#20) will flash. Press PLAY/PAUSE  BUTTON (#23) again to resume playing.
6. Adjust the VOLUME CONTROL (#28) to the desired volume level.
7. Press CD STOP  BUTTON (#16) to stop playing.
8. To turn off the CD player, slide the FUNCTION SELECTOR (#29) to OFF/TAPE position.

NOTE: If skipping occurs during CD play, try turning the volume down. Do not open the CD DOOR when a CD is playing.

REPEAT MODE

Repeat 1:

Tap the REPEAT BUTTON (#17), the REPEAT INDICATOR (#21) will flash. The current track will be repeated until it is interrupted.





Repeat All:

Tap the REPEAT BUTTON (#17) again, the REPEAT INDICATOR (#21) will light up and stay lit. The whole disc will be played repeatedly.

To Cancel Repeat Function:

Tap the REPEAT BUTTON (#17) again. The REPEAT INDICATOR (#21) will turn off.

SKIP AND SEARCH MODE

1. During Play or Pause mode, tap the CD SKIP+  BUTTON (#15) or CD SKIP-  BUTTON (#22) to go to the next track or go back to the beginning of the current track.
2. During play mode or Pause mode, press and hold the SEARCH CD F.FWD  BUTTON (#11) or CD REWIND  BUTTON (#18) to search within the current track with audible high speed playback.

PROGRAM PLAY MODE

This function allows music tracks to be played in a programmed sequence.



NOTE: Program can only be set in STOP mode.

1. Press the PROGRAM BUTTON (#10) once. The program number 01 and the PROGRAM INDICATOR (#14) on the LED DISPLAY both will flash.
2. Press the CD SKIP+ ►►I BUTTON (#15) or CD SKIP- I◄◄ BUTTON (#22) to select the track to be programmed.
3. Press the PROGRAM BUTTON (#10) again to store the selection. The LED DISPLAY (#13) will advance to 02 and flash to prompt for the next input.
4. You may repeat steps 2 to 3 to program up to 20 tracks. As soon as you have entered the 20th track, the LED DISPLAY (#13) will automatically show the programmed tracks one by one in their correct sequence starting from the first. At the end of program review, program number 01 and the PROGRAM INDICATOR (#14) on the LED DISPLAY (#13) will both flash.
5. Press the CD PLAY/PAUSE ►II BUTTON (#23) to complete and start program play. The PROGRAM INDICATOR (#14) on the LED display will light up. Press the CD STOP ■ BUTTON (#16) to stop.
6. Normally all the programmed tracks will be played through once and then stop. However, you may use the REPEAT function to repeatedly play a certain track (Repeat 1) or all tracks (Repeat All) in the program. You may also tap the CD SKIP+ ►►I BUTTON (#15) to go directly to other tracks ahead or the CD SKIP- I◄◄ BUTTON (#22) to go back to previous track(s) during program play.
7. To edit the programmed tracks during program playback, press the CD STOP ■ BUTTON (#16) and then the PROGRAM BUTTON (#10). Program number 01 and PROGRAM INDICATOR (#14) on the LED DISPLAY (#13) will both flash.
 - a. If you do not want to change any track in the program, press STOP BUTTON.
 - b. To edit a programmed track, tap the PROGRAM BUTTON (#10) repeatedly until you reach the program number whose track you want to change. Tap the SKIP+ ►►I BUTTON (#15) or the CD SKIP- I◄◄ BUTTON (#22) to select a new track and press PROGRAM BUTTON (#10) to confirm.
8. To cancel program play, press the CD STOP ■ BUTTON (#16) twice while program playback is running or open the CD DOOR in stop mode. The PROGRAM INDICATOR (#14) will go off.





BLUETOOTH OPERATION

PAIRING A SMARTPHONE OR BLUETOOTH ENABLED DEVICE

The Bluetooth feature enables you to stream and play the digital music on your Bluetooth enabled device to your unit.

1. Check your Bluetooth enabled device and make sure the Bluetooth feature is turned on. Refer to manual of your smartphone or external Bluetooth enabled device if needed
2. Slide the FUNCTION SELECTOR (#29) to the /CD/AUX position.
3. Press and hold the BLUETOOTH  BUTTON (#23) to enter Bluetooth mode.
4. "bt" will flash on the LED DISPLAY (#13) and the unit will go into Pairing mode.
5. Enable the Bluetooth function of the device you want to link to and enable the search or scan function to find the CD-550BT.
6. Select "CD-550BT" from the list when it appears on your device screen. If required, enter the pass code "0000" to pair (link) CD-550BT with your device.
7. If you are pairing (linking) your computer to the speaker using Bluetooth, you may need to set the CD-550BT as your computer's default sound device.
8. After successfully pairing the CD-550BT with your Bluetooth device, The "bt" will stop flashing and remain lit.
9. If you want to pair (link) the CD-550BT with another Bluetooth device, press and hold the BLUETOOTH PAIR BUTTON (#16) a few seconds. The "bt" will flash. The CD-550BT will go into Pairing/Discoverable mode. Repeat steps 4 & 5.

Now you can play music from your Bluetooth device wirelessly to the CD-550BT.

1. Select your favorite song, press the Play/Pause  Button on your Bluetooth device or the CD PLAY/PAUSE  BUTTON (#23) on the CD-550BT to play or pause the song from your Bluetooth device.
2. Press the CD SKIP+  BUTTON (#15) or CD SKIP-  BUTTON (#22) to select the Next or Previous track.
(The SEARCH function does not apply to Bluetooth operation)
3. Slowly adjust both the volume controls of your CD-550BT and your Bluetooth device until you reach a comfortable listening level.

Notes :

1. Refer to the manual of your cell phone, tablet PC, computer or other Bluetooth enabled devices for Bluetooth operation since it may vary from model to model.
2. If your Bluetooth enabled device does not support A2DP profile, it will not play the music through the speaker, even if paired (linked).
3. Remember to turn off the CD-550BT when you have finished listening, set the Function Selector (#29) to the "OFF/TAPE" position
4. Don't forget to switch off the power of your Bluetooth device as well.
5. The music playback will automatically be paused when you have an incoming call. When the call is ended, the CD-550BT will start playing again.

CASSETTE PLAYER / RECORDER OPERATION

1. Press the CASSETTE STOP/EJECT ■ ▲ BUTTON (#5) to open the Cassette Door and insert a pre-recorded cassette tape with the exposed tape facing upwards. Push the Cassette Door to close it.
2. Slide the FUNCTION SELECTOR (#29) to OFF/TAPE position, press the CASSETTE PLAY ◀ BUTTON (#8) to start playback and adjust the Rotary Volume Control to obtain the desired sound level.
3. Press the CASSETTE F.FWD ◀◀ BUTTON (#6) or the CASSETTE REW ▶▶ BUTTON (#7) to rapidly advance or rewind the tape.
4. Press the CASSETTE PAUSE || BUTTON (#4) to pause the playback, press it again to resume the playback.
5. Press the CASSETTE STOP/EJECT ■ ▲ BUTTON (#5) to stop operation.

Recording from the Radio/Bluetooth/CD/Auxiliary source

1. Set the FUNCTION SELECTOR (#29) to OFF/TAPE position.
2. Press the CASSETTE STOP/EJECT ■ ▲ BUTTON (#5) to open the cassette holder.
3. Insert a tape and close the Cassette Holder.
4. Select the desired sound source with the FUNCTION SELECTOR (#29).
In radio mode, tune to your desired radio station.
In Bluetooth mode, start playback from your Bluetooth device.
In CD mode, start playback from the CD player.
In AUX mode, start playback from your auxiliary source.
5. Press CASSETTE RECORD ● BUTTON (#9). The CASSETTE PLAY ◀ BUTTON (#8) is depressed automatically.
6. To pause recording, press the CASSETTE PAUSE || BUTTON (#4). Press the CASSETTE PAUSE || BUTTON (#4) again to resume recording.
7. To stop recording, press the CASSETTE STOP/EJECT ■ ▲ BUTTON (#5).
8. To listen to your recording, set the FUNCTION SELECTOR (#29) to OFF/TAPE position.
Press the CASSETTE REW ▶▶ BUTTON (#7) to rewind the tape to search your recording, and then press the CASSETTE PLAY ◀ BUTTON (#8) to listen.

AUTOMATIC STOP

To protect your cassette tapes and prevent unnecessary wear to the pinch roller of the cassette mechanism, this unit is equipped with an Automatic Stop System. When the tape ends during play, the CASSETTE PLAY ◀ BUTTON (#8) will automatically release to stop the cassette from running.

AUX IN OPERATION

This unit provides an AUX IN JACK (#25) for connecting external audio devices like MP3 players, CD players, smart phones and iPods (except iPod shuffle 3rd generation) to listen to your external source through the speakers of this system.

1. You need an audio cable (not included) with one 3.5 mm stereo plug on each end of the cable.
2. Plug one end of the cable into the AUX IN JACK (#25) located on the left-hand side of the unit and the other end of the cable into the Line-out Jack or Headphone Jack of your external audio device.
3. Turn on the external audio device.
4. Turn on the unit by setting the FUNCTION SELECTOR (#29) to /CD/AUX position.
5. The volume level can now be controlled through the VOLUME CONTROL (#28) of the unit. Operate all other functions on the auxiliary device as usual.
6. Set the FUNCTION SELECTOR (#29) to OFF/TAPE position to turn off the unit.

Notes:

- If you connected the Line-out Jack on your external device then you only need to adjust the volume control of this system. If you connected the Headphone Jack of your external device then you may need to adjust both the volume control of your external device and the volume control of this system to find the most desirable volume setting.
- Remove the audio cable from AUX IN JACK (#25) when you finish listening. Don't forget to switch off the power on your external device as well.

USING HEADPHONES (NOT INCLUDED)

Inserting the plug of your headphones into the HEADPHONES JACK (#26) will enable you to listen to the Bluetooth, CD, AUX, Radio or Cassette music in private. When using headphones, the Built-in Speakers will be disconnected.

CAUTION:

- Avoid excessive volume levels for long period of time when using the earphones. Prolonged use at high levels may impair your hearing.
- Keep the volume at a reasonable level even if your headset is an open-air type designed to allow you to hear outside sounds. Please note that excessively high volume may still block outside sounds.

CARE AND MAINTENANCE

1. Do not subject the unit to excessive force, shock, dust or extreme temperature.
2. Do not tamper the internal components of the unit.
3. Clean your unit with a dry cloth. Solvent or detergent should never be used.
4. Avoid leaving your unit in direct sunlight or in hot, humid or dusty places.
5. Keep your unit away from heating appliances and sources of electrical noise such as fluorescent lamps or motors.
6. If drop-outs or interruptions occur in the music during CD play, or if the CD fails to play at all, its bottom surface may require cleaning. Before playing, wipe the disc from the center outwards with a good soft cleaning cloth.

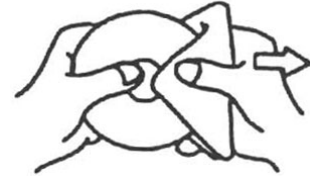

ABOUT CASSETTE TAPES

Whenever you record on a cassette any previously recorded material is erased as the new material is recorded. To prevent you from accidentally erasing material which you wish to save, blank cassettes are equipped with erase prevention tabs for each side of the tape. If the erase prevention tab for side A is removed, you cannot accidentally record on side A. The Record ● key cannot be depressed if the erase prevention tab on the cassette has been removed.

To prevent accidental erasing on side A of a cassette use a small screw driver or similar tool to break off the erase prevention tab for side A. This prevents the record key from locking.



If later you do wish to record on side A of the cassette, cover the tab opening with a piece of cellophane tape. This will allow the Record ● to function again.

CASSETTE CARE

Two common causes of trouble experienced when using cassettes are:

- 1) Tape Jamming – Leading to uneven speed in playback, and
- 2) Tape Tangling – Where the tape wraps itself around vital parts of the mechanism.

To reduce the likelihood of these problems occurring, the following precautions should be observed:

- Check that there are no loose layers of tape visible through the cassette center window (see Fig. 1). Take up any loose layers, using a pencil or hexagonal barreled ballpoint pen, before inserting the cassette into the machine (see Fig.2)

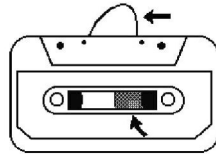

Fig.1

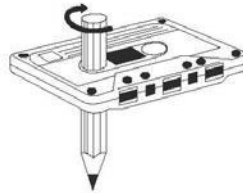

Fig. 2

- If the cassette feels tight while performing operation shown (see Fig.2), the tape may be jamming due to ridges formed in the winding of the tape (visible through the center window). These may be removed, in most cases, by fast winding of the cassette from one end to the other and back again.
- Use only well-known brands of tape. Avoid use of C-120 cassettes.

Furthermore, do not expose cassettes to direct sunlight, dust or oil, and do not touch the tape surfaces.

HEAD CLEANING

The tape heads, pinch roller and capstan require periodic cleaning. This removes particles of the metal oxide coating that wear off the tape and accumulate on these parts and impair performance. Switch off the power, press the CASSETTE STOP/EJECT ■ ▲ BUTTON (#5) to open the cassette door, and press the CASSETTE PLAY ◀ BUTTON (#8). Clean the tape heads, pinch roller and capstan with a soft cloth or cotton pad dampened in isopropyl alcohol or special tape head cleaner.

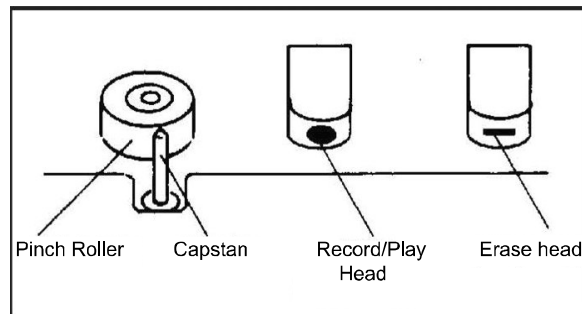

1. Avoid operating your unit under direct sunlight or in hot, humid or dusty places.
2. Keep your unit away from heating appliances and sources of electrical noise such as fluorescent lamps or motors.
3. For better Display clarity, avoid operating the unit under direct sunlight or in strong room illumination.
4. Unplug the unit from the electrical power outlet immediately in case of malfunction.

TROUBLE SHOOTING GUIDE

If you experience difficulties in the use of this unit, please check the following or call 1-800-777-5331 for Customer Service and support

Symptom	Possible Cause	Solution
Noise or sound distorted on AM or FM broadcast	<ul style="list-style-type: none"> - Station not tuned properly for AM or FM. - The internal antennas are not positioned correctly 	<ul style="list-style-type: none"> - Retune the AM or FM broadcast station. - Reposition the unit until the best reception is obtained.
AM or FM no sound	<ul style="list-style-type: none"> - Unit not in "RADIO" function mode. - Volume set at minimum 	<ul style="list-style-type: none"> - Slide FUNCTION SWITCH to "AM" or "FM ST" position. - Increase Volume.
CD player will not play	<ul style="list-style-type: none"> - Unit not in CD function mode. - CD is not loaded properly. - If the CD is self-compiled, the media used may not be compatible with the player. 	<ul style="list-style-type: none"> - Select CD function mode. - Load CD with label side up. - Use better quality blank media and retest.
CD skips while playing	Disc is dirty or scratched.	Wipe CD with clean cloth or use another disc.
Intermittent sound from CD player	<ul style="list-style-type: none"> - Dirty or defective disc - Dirty pick up lens - Player is subject to excessive shock or vibration 	<ul style="list-style-type: none"> - Clean or replace the defective disc. - Use a CD lens cleaning disc to clean the lens. - Relocate the player away from shock or vibration.
Cassette Player no sound	<ul style="list-style-type: none"> - Unit not at TAPE function mode - Volume at minimum 	<ul style="list-style-type: none"> - Slide function selector to TAPE - Increase volume
Sound distorted	Dirty tape head	Clean the head
Speed varies	<ul style="list-style-type: none"> - Tape old or worn - Dirty roller and capstan 	<ul style="list-style-type: none"> - Replace the tape - Clean roller and capstan
Cassette Recorder will not record	Prevention tab removed	Cover hole with tape
Distorted sound on playback	Defective tape or dirty tape head	Replace tape or clean tape head
Sound appears distorted at high volume setting	Volume control is set to maximum.	Adjust Volume control to a lower comfortable level
Bluetooth no operation	<ul style="list-style-type: none"> - Unit not in correct function mode - Bluetooth connect unstable 	<ul style="list-style-type: none"> - Slide FUNCTION Selector to  position - Try reconnecting again

The Bluetooth® word mark and logos are registered trademarks owned by Bluetooth SIG, Inc. and any use of such marks by Spectra Merchandising Intl, Inc. is under license. Other trademarks and trade names are those of their respective owners.

SPECIFICATION

Power Sources: 120V~, 60Hz, 14 W or
DC9V (6 X 1.5V, "C" size, UM-2 batteries)
Frequency Range: AM 520 - 1710 kHz
FM 88 - 108 MHz



At Spectra, environmental and social responsibility is a core value of our business. We are dedicated to continuous implementation of responsible initiatives with an aim to conserve and maintain the environment through responsible recycling.

Please visit us at <http://www.spectraintl.com/green.htm> for more information on Spectra's green initiatives or to find a recycler in your area.

1 YEAR LIMITED WARRANTY AND SERVICE VALID IN THE U.S.A. ONLY

SPECTRA MERCHANDISING INTERNATIONAL, INC. warrants this unit to be free from defective materials or factory workmanship for a period of 1 year from the date of original customer purchase and provided the product is utilized within the U.S.A. This warranty is not assignable or transferable. Our obligation under this warranty is the repair or replacement of the defective unit or any part thereof, except batteries, when it is returned to the SPECTRA Service Department, accompanied by proof of the date of original consumer purchase, such as a duplicate copy of a sales receipt.

You must pay all shipping charges required to ship the product to SPECTRA for warranty service. If the product is repaired or replaced under warranty, the return charges will be at SPECTRA's expense. There are no other express warranties other than those stated herein.

This warranty is valid only in accordance with the conditions set forth below:

1. The warranty applies to the SPECTRA product only while:
 - a. It remains in the possession of the original purchaser and proof of purchase is demonstrated.
 - b. It has not been subjected to accident, misuse, abuse, improper service, usage outside the descriptions and warnings covered within the user manual or non-SPECTRA approved modifications.
 - c. Claims are made within the warranty period.
2. This warranty does not cover damage or equipment failure caused by electrical wiring not in compliance with electrical codes or SPECTRA user manual specifications, or failure to provide reasonable care and necessary maintenance as outlined in the user manual.
3. Warranty of all SPECTRA products applies to residential use only and is void when products are used in nonresidential environment or installed outside the United States.

This warranty gives you specific legal rights, and you may also have other rights which vary from state to state. TO OBTAIN SERVICE please remove all batteries (if any) and pack the unit carefully and send it freight prepaid to SPECTRA at the address shown below. IF THE UNIT IS RETURNED WITHIN THE WARRANTY PERIOD shown above, please include a proof of purchase (dated cash register receipt) so that we may establish your eligibility for warranty service and repair of the unit without cost. Also include a note with a description explaining how the unit is defective. A customer service representative may need to contact you regarding the status of your repair, so please include your name, address, phone number and email address to expedite the process.

It is recommended that you contact SPECTRA first at 1-800-777-5331 or by email at custserv@spectraintl.com for updated information on the unit requiring service. In some cases, the model you have may be discontinued, and SPECTRA reserves the right to offer alternative options for repair or replacement.

SPECTRA MERCHANDISING INTERNATIONAL, INC.

4230 North Normandy Avenue,

Chicago, IL60634, USA. 1-800-777-5331

To register your product, visit the link on the website below to enter your information.

<http://www.spectraintl.com/wform.htm>

0724

Printed in China
(CD-550ABT-BK/GR/RG/BL/L)