

Studebaker

**3-SPEED TURNTABLE WITH AM/FM STEREO
RECEIVER AND CASSETTE PLAYER**

SB6052 OWNER'S MANUAL



Please read this Instruction Manual carefully before using
the unit and retain it for future reference

IMPORTANT SAFETY INSTRUCTIONS

WARNING:

TO REDUCE THE RISK OF FIRE OR ELECTRIC SHOCK, DO NOT EXPOSE THIS APPLIANCE TO RAIN OR MOISTURE. DANGEROUS HIGH VOLTAGES ARE PRESENT INSIDE THE ENCLOSURE. DO NOT OPEN THE CABINET REFER SERVICING TO QUALIFIED PERSONNEL ONLY.



THE CAUTION MARKING IS LOCATED AT THE BACK OF THE UNIT
THE RATING PLATE IS LOCATED AT THE BACK OF THE UNIT

CAUTION:

PLEASE READ AND OBSERVE ALL WARNINGS AND INSTRUCTIONS GIVEN IN THIS OWNER'S MANUAL AND THOSE MARKED ON THE UNIT, KEEP THESE INSTRUCTIONS. RETAIN THIS BOOKLET FOR FUTURE REFERENCE.

THIS SET HAS BEEN DESIGNED AND MANUFACTURED TO ASSURE PERSONAL SAFETY. IMPROPER USE CAN RESULT IN ELECTRIC SHOCK OR FIRE HAZARD. THE SAFEGUARDS INCORPORATED IN THIS UNIT WILL PROTECT YOU IF YOU OBSERVE THE FOLLOWING PROCEDURES FOR INSTALLATION, USE AND SERVICING. THIS UNIT DOES NOT CONTAIN ANY PARTS THAT CAN BE REPAIRED BY THE USER.



THE SYMBOL FOR CLASS II (DOUBLE INSULATION)

DO NOT REMOVE THE CABINET COVER, OR YOU MAY BE EXPOSED TO DANGEROUS VOLTAGE. REFER SERVICING TO QUALIFIED SERVICE PERSONNEL ONLY.

1. READ THESE INSTRUCTIONS.
2. KEEP THESE INSTRUCTIONS.
3. HEED ALL WARNINGS.
4. FOLLOW ALL INSTRUCTIONS.
5. DO NOT USE THIS APPARATUS NEAR WATER.

6. CLEAN ONLY WITH A DRY CLOTH.
7. DO NOT BLOCK ANY OF THE VENTILATION OPENINGS. INSTALL IN ACCORDANCE WITH THE MANUFACTURER'S INSTRUCTIONS.
8. DO NOT INSTALL NEAR ANY HEAT SOURCES SUCH AS RADIATORS, HEAT REGISTERS, STOVES, OR OTHER APPARATUS (INCLUDING AMPLIFIERS) THAT PRODUCE HEAT.
9. DO NOT DEFEAT THE SAFETY PURPOSE OF THE POLARIZED OR GROUNDING – TYPE PLUG. A POLARIZED PLUG HAS TWO BLADES WITH ONE WIDER THAN THE OTHER. A GROUNDING TYPE PLUG HAS TWO BLADES AND A THIRD GROUNDING PRONG. THE WIDE BLADE OR THE THIRD PRONG IS PROVIDED FOR YOUR SAFETY. IF THE PROVIDED PLUG DOES NOT FIT INTO YOUR OUTLET, CONSULT AN ELECTRICIAN FOR REPLACEMENT OF THE OBSOLETE OUTLET.
10. PROTECT THE POWER CORD FROM BEING WALKED ON OR PINCHED PARTICULARLY AT PLUGS, CONVENIENCE RECEPTACLES AND THE POINT WHERE THEY EXIT FROM THE APPARATUS.
11. ONLY USE ATTACHMENTS/ACCESSORIES SPECIFIED BY THE MANUFACTURER.
12. USE ONLY WITH A CART, STAND, TRIPOD, BRACKET, OR TABLE SPECIFIED BY THE MANUFACTURER, OR SOLD WITH THE APPARATUS. WHEN A CART IS USED, USE CAUTION WHEN MOVING THE CART/APPARATUS COMBINATION TO AVOID INJURY FROM TIP-OVER.
13. UNPLUG THIS APPARATUS DURING LIGHTNING STORMS OR WHEN UNUSED FOR LONG PERIODS OF TIME.
14. REFER ALL SERVICING TO QUALIFIED SERVICE PERSONNEL. SERVICING IS REQUIRED WHEN THE APPARATUS HAS BEEN DAMAGED IN ANYWAY, SUCH AS POWER-SUPPLY CORD OR PLUG IS DAMAGED, LIQUID HAS BEEN SPILLED OR OBJECTS HAVE FALLEN INTO THE APPARATUS, THE APPARATUS HAS BEEN EXPOSED TO RAIN OR MOISTURE, DOES NOT OPERATE NORMALLY OR HAS BEEN DROPPED.
15. THE APPARATUS SHALL NOT BE EXPOSED TO DRIPPING OR SPLASHING AND THAT NO OBJECTS FILLED WITH LIQUIDS, SUCH AS VASES, SHALL BE PLACED ON APPARATUS.
16. MAIN PLUG IS USED AS DISCONNECT DEVICE AND IT SHOULD REMAIN READILY OPERABLE DURING INTENDED USE. IN ORDER TO DISCONNECT THE APPARATUS FROM THE MAINS COMPLETELY, THE MAINS PLUG SHOULD BE DISCONNECTED FROM THE MAINS SOCKET OUTLET COMPLETELY.



CAUTION:

TO PREVENT ELECTRIC SHOCK, MATCH WIDE BLADE OF PLUG TO WIDE SLOT. FULLY INSERT.

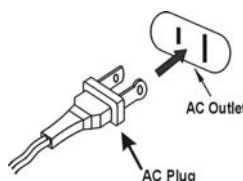

FCC NOTICE

THIS EQUIPMENT HAS BEEN TESTED AND FOUND TO COMPLY WITH THE LIMITS FOR A RADIO RECEIVER, PURSUANT TO PART 15 OF THE FCC RULES. THESE LIMITS ARE DESIGNED TO PROVIDE REASONABLE PROTECTION AGAINST HARMFUL INTERFERENCE IN A RESIDENTIAL INSTALLATION. THIS EQUIPMENT GENERATES, USES AND CAN RADIATE RADIO FREQUENCY ENERGY AND, IF NOT INSTALLED AND USED IN ACCORDANCE WITH THE INSTRUCTIONS, MAY CAUSE HARMFUL INTERFERENCE TO RADIO COMMUNICATIONS.

HOWEVER, THERE IS NO GUARANTEE THAT INTERFERENCE WILL NOT OCCUR IN A PARTICULAR INSTALLATION. IF THIS EQUIPMENT DOES CAUSE HARMFUL INTERFERENCE TO RADIO OR TELEVISION RECEPTION, WHICH CAN BE DETERMINED BY TURNING THE EQUIPMENT OFF AND ON, THE USER IS ENCOURAGED TO TRY TO CORRECT THE INTERFERENCE BY ONE OR MORE OF THE FOLLOWING MEASURES:

- REORIENT OR RELOCATE THE RECEIVING ANTENNA.
- INCREASE THE SEPARATION BETWEEN THE EQUIPMENT AND RECEIVER.
- CONNECT THE EQUIPMENT INTO AN OUTLET ON A CIRCUIT DIFFERENT FROM THAT TO WHICH THE RECEIVER IS NEEDED.
- CONSULT THE DEALER OR AN EXPERIENCED RADIO/TV TECHNICIAN FOR HELP.

WARNING:

CHANGES OR MODIFICATIONS TO THIS UNIT NOT EXPRESSLY APPROVED BY THE PARTY RESPONSIBLE FOR COMPLIANCE COULD VOID THE USER'S AUTHORITY TO OPERATE THE EQUIPMENT.

PROTECT YOUR FURNITURE!!

THIS SYSTEM IS EQUIPPED WITH NON-SKID RUBBER 'FEET' TO PREVENT THE PRODUCT FROM MOVING WHEN YOU OPERATE THE CONTROLS. THESE 'FEET' ARE MADE FROM NON-MIGRATING RUBBER MATERIAL SPECIALLY FORMULATED TO AVOID LEAVING ANY MARKS OR STAINS ON YOUR FURNITURE. HOWEVER CERTAIN TYPES OF OIL BASED FURNITURE POLISHES, WOOD PRESERVATIVES, OR CLEANING SPRAYS MAY CAUSE THE RUBBER 'FEET' TO SOFTEN, AND LEAVE MARKS OR A RUBBER RESIDUE ON THE FURNITURE.

TO PREVENT ANY DAMAGE TO YOUR FURNITURE WE STRONGLY RECOMMEND THAT YOU PURCHASE SMALL SELF-ADHESIVE FELT PADS, AVAILABLE AT HARDWARE STORES AND HOME IMPROVEMENT CENTERS EVERYWHERE, AND APPLY THESE PADS TO THE BOTTOM OF THE RUBBER 'FEET' BEFORE YOU PLACE THE PRODUCT ON FINE WOODEN FURNITURE.

LOCATION OF CONTROLS

- 1) DUST COVER
- 2) LEFT SPEAKER
- 3) DIAL SCALE
- 4) TUNING KNOB
- 5) FUNCTION SELECTOR (PHONO/TAPE/AM/FM)
- 6) FM STEREO INDICATOR
- 7) RIGHT SPEAKER
- 8) POWER ON/OFF AND VOLUME CONTROL
- 9) POWER LED INDICATOR
- 10) TAPE FORWARD/EJECT BUTTON
- 11) CASSETTE DOOR
- 12) 45 RPM ADAPTOR
- 13) 33/45/78 RPM SPEED SELECTOR
- 14) TONE ARM CLAMP
- 15) AUTO STOP SWITCH
- 16) FM STEREO/MONO SWITCH
- 17) LINE OUT SOCKET
- 18) FM ANTENNA
- 19) AC CORD

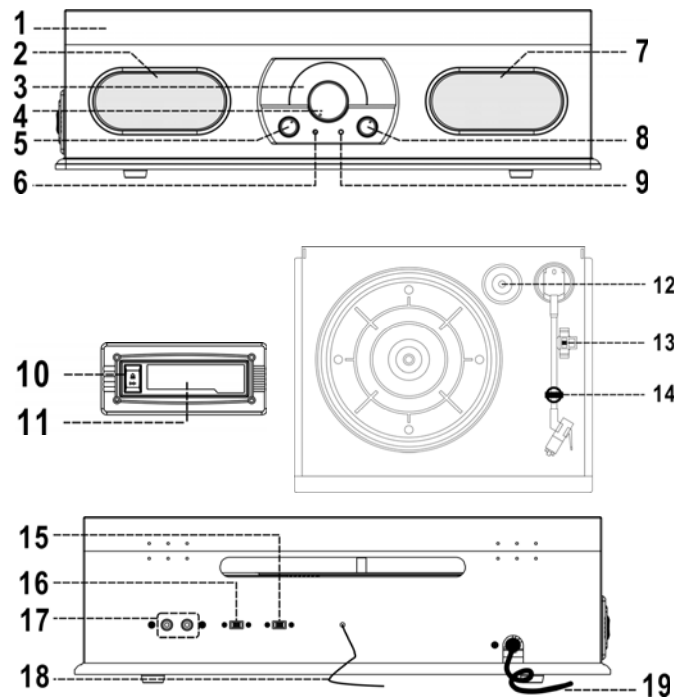

CAUTION:

THIS UNIT SHOULD NOT BE ADJUSTED OR REPAIRED BY ANYONE EXCEPT QUALIFIED SERVICE PERSONNEL.

PRECAUTIONS FOR USE

- UNPACK ALL PARTS AND REMOVE THE PROTECTIVE MATERIAL.
- DO NOT CONNECT THE UNIT TO THE MAINS BEFORE CHECKING THE MAINS VOLTAGE.
- DO NOT COVER ANY VENTS AND MAKE SURE THAT THERE IS A SPACE OF SEVERAL INCHES AROUND THE UNIT FOR VENTILATION.

POWER CONNECTION

1. CONNECT THE POWER CORD (16) TO A 120V AC ~ 60Hz OUTLET.
2. TURN ON THE POWER (8) BY ROTATING THE VOLUME CONTROL CLOCKWISE UNTIL A CLICK IS HEARD. IF THE POWER LED INDICATOR (9) IS ON WITH RED LIGHT, IT MEANS THAT THE POWER SUPPLY IS NORMAL. NOW YOUR SYSTEM IS READY TO PLAY THE MUSIC.

LISTENING TO RADIO

1. SET THE FUNCTION SELECTOR (5) TO THE DESIRED RADIO BAND (AM OR FM).
2. TUNE TO THE REQUIRED STATION BY TURNING THE TUNING KNOB (4).
3. ADJUST THE VOLUME CONTROL (8) TO OBTAIN THE DESIRED SOUND LEVEL.

FM & FM-STEREO RECEPTION

- WHEN THE FM STEREO MONO SWITCH (16) IS SET TO THE "MONO" POSITION, PROGRAMS ARE RECEIVED IN MONO MODE. IN PARTICULAR WHEN STEREO SIGNALS ARE WEAK, IT IS PREFERABLE TO RECEIVE THE PROGRAM IN MONO.
- SET THE FM STEREO MONO SWITCH (16) TO THE "STEREO" POSITION TO RECEIVE STEREO PROGRAMS. THE LED "ST" INDICATOR (6) WILL LIGHT UP TO SHOW THAT FM STEREO PROGRAM IS RECEIVED.

HINTS FOR BEST RECEPTION:-

- AM: THE RECEIVER HAS A BUILT-IN AM BAR ANTENNA. IF AM RECEPTION IS WEAK, SLIGHTLY

- ROTATING OR RE-POSITIONING OF THE UNIT WILL USUALLY IMPROVE THE AM RECEPTION.
- FM: THE RECEIVER HAS A BUILT-IN FM WIRE ANTENNA (18). THIS WIRE SHOULD BE TOTALLY UNRAVELED AND EXTENDED FOR BEST RECEPTION. IF FM RECEPTION IS WEAK TRY REPOSITIONING THE FM WIRE ANTENNA UNTIL YOU FIND THE STRONGEST FM SIGNAL.

PLAYING PHONO RECORDS

1. RAISE THE TURNTABLE DUST COVER.
2. REMOVE THE STYLUS PROTECTOR AND RELEASE THE TONE ARM CLAMP (14).
3. SET THE FUNCTION SELECTOR (5) TO "PHONO".
4. PLACE A RECORD ON THE TURNTABLE, OVER THE CENTER SPINDLE.
5. SET THE SPEED SELECTOR SWITCH (13) TO 33, 45 OR 78 RPM ACCORDING TO THE RECORD YOU ARE PLAYING. PLACE THE INCLUDED 45 RPM ADAPTOR (12) OVER THE CENTER SPINDLE WHEN PLAYING 45 RPM RECORDS.
6. MOVE THE TONE ARM TO THE BEGINNING OF THE RECORD OR TO THE BEGINNING OF A PARTICULAR TRACK. GENTLY LOWER THE TONE ARM ONTO THE RECORD TO START PLAYING.
7. ADJUST THE VOLUME IF NEEDED. THE TURNTABLE WILL STOP AUTOMATICALLY WHEN THE RECORD FINISHES.
8. TO STOP THE RECORD BEFORE IT ENDS, LIFT THE TONE ARM AND RETURN IT CAREFULLY ONTO THE TONE ARM CLAMP (14).
9. REPLACE THE STYLUS PROTECTOR ON THE STYLUS WHEN NOT IN USE.

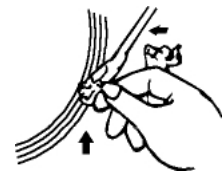
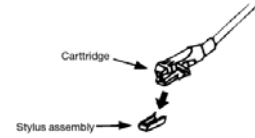

IMPORTANT:

- I. DO NOT STOP OR TURN THE PLATTER MANUALLY.
- II. MOVING OR JARRING THE TURNTABLE WITHOUT SECURING THE TONE ARM CLAMP COULD RESULT IN DAMAGE TO THE TONE ARM.

AUTO-STOP SWITCH OPERATION

THE AUTO-STOP AREA ON SOME RECORDS MAY EXTEND BEYOND THE PRESET SETTING. AS A RESULT THE TURNTABLE COULD POSSIBLY STOP BEFORE THE LAST TRACK FINISHES. IF YOU EXPERIENCE THIS DURING PLAYBACK, SET THE AUTO-STOP SWITCH (15) LOCATED ON THE BACK OF THE UNIT TO THE "OFF" POSITION. THE TURNTABLE WILL NOW RUN TO THE END OF THE RECORD BUT WILL NO LONGER STOP AUTOMATICALLY. TO STOP THE TURNTABLE YOU WILL NEED TO EITHER SET THE FUNCTION SELECTOR (5) TO ANOTHER POSITION OTHER THAN PHONO OR RETURN THE AUTO-STOP SWITCH (15) TO THE "ON" POSITION. AFTER THE RECORD STOPS, LIFT AND RETURN THE TONE ARM CAREFULLY BACK ONTO THE TONE ARM CLAMP (14).

LISTENING TO TAPE

PLAYBACK : SET THE FUNCTION SELECTOR (5) TO "TAPE".
LOAD CASSETTE TAPE INTO THE UNIT (LOCATED ON SIDE OF
THE UNIT) PLAYBACK WILL AUTOMATICALLY BEGIN
ADJUST THE VOLUME CONTROL (8) TO OBTAIN THE DESIRED
SOUND LEVEL..

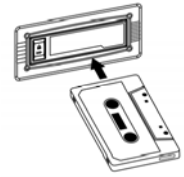

FAST FORWARD : PRESS BUTTON HALFWAY TO FAST FORWARD THE TAPE.
PRESS BUTTON LIGHTLY AND PLAYBACK WILL RESUME.

STOP AND EJECTION : PRESS BUTTON ALL THE WAY TO END PLAYBACK AND EJECT TAPE.

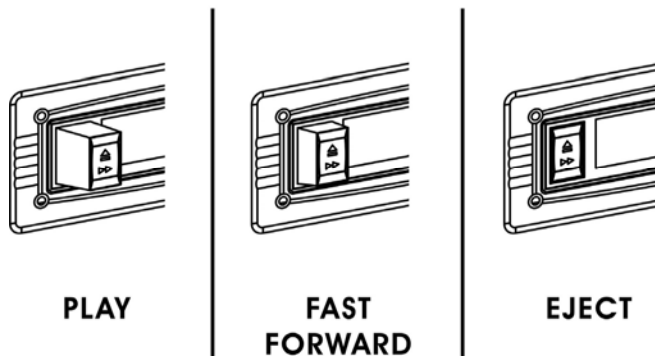

REMARK:

- MAKE SURE THE TAPE DIRECTION IS CORRECT WHEN INSERTING IT INTO THE CASSETTE DECK.
- IT IS RECOMMENDED TO REMOVE THE CASSETTE TAPE FROM THE SYSTEM EVERY TIME AFTER FINISHED LISTENING. DO NOT LEAVE THE CASSETTE TAPE INSIDE THE SYSTEM WHEN NOT IN TAPE PLAYBACK MODE.

LINE OUT OPERATION

FOR BETTER PLAYBACK SOUND, YOU CAN CONNECT THE SB6052 TO AN EXTERNAL AUDIO AMPLIFIER VIA THE RCA LINE OUT JACKS LOCATED ON THE BACK PANEL. PLEASE PROCEED AS FOLLOWING:

1. CONNECT THE "L" & "R" LINE OUT JACKS AND THE AUX IN OF YOUR AUDIO AMPLIFIER. (CONNECTION CABLE IS NOT INCLUDED).
2. SELECT THE MUSIC SOURCE BY SETTING THE FUNCTION SELECTOR (5) TO "PHONO", "TAPE", "AM", "FM" OR "FM ST" AS DESIRED.
3. TURN ON THE EXTERNAL AMPLIFIER.
4. SOUND WILL THEN COME OUT FROM THE SYSTEM'S BUILT-IN SPEAKERS AND THE EXTERNAL AMPLIFIER'S SPEAKERS SIMULTANEOUSLY.
5. SET THE VOLUME CONTROL (8) TO "MIN" AND ADJUST THE SOUND LEVEL USING THE VOLUME CONTROL ON THE EXTERNAL AMPLIFIER AS DESIRED.
6. TURN THE SYSTEM AND THE EXTERNAL AMPLIFIER OFF WHEN YOU HAVE FINISHED LISTENING.
7. UNPLUG THE CONNECTION CABLE.

STYLUS REPLACEMENT

PLEASE REFER TO THE DIAGRAM BELOW TO REPLACE THE STYLUS.

NO ADDITIONAL STYLUS IS SUPPLIED WITH THE SYSTEM.

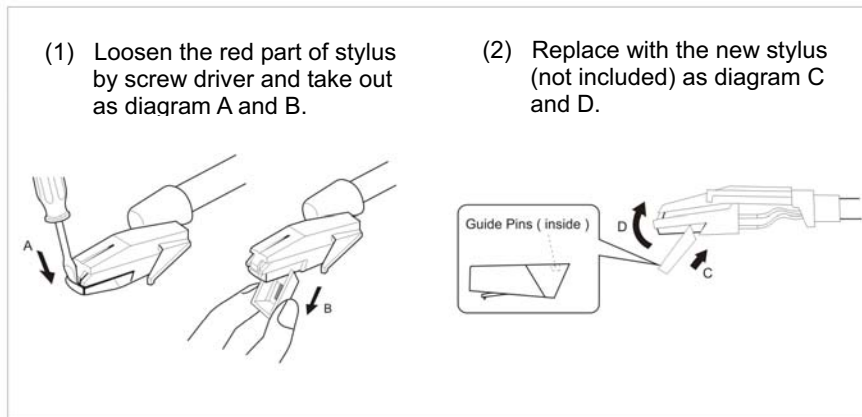

CARE AND MAINTENANCE

CLEAN YOUR UNIT WITH A DAMP (NEVER WET) CLOTH. SOLVENT OR DETERGENT SHOULD NEVER BE USED.

1. AVOID LEAVING YOUR UNIT IN DIRECT SUNLIGHT OR IN HOT, HUMID OR DUSTY PLACES.
2. KEEP YOUR UNIT AWAY FROM HEATING APPLIANCES AND SOURCES OF ELECTRICAL NOISE SUCH AS FLUORESCENT LAMPS OR MOTORS.
3. ALWAYS CLEAN THE OUTSIDE OF THE CABINET THOROUGHLY IF IT BECOMES WET WITH MOISTURE OR WATER SPLASHES. THIS WILL HELP TO PROTECT THE INTERNAL PARTS OF THE UNIT FROM ENTRY OF WATER AND POSSIBLE MOISTURE DAMAGE.

TROUBLESHOOTING GUIDE

SHOULD YOU EXPERIENCE DIFFICULTIES IN THE USE OF THIS PLAYER PLEASE REFER TO THE FOLLOWING CHART OR CALL 1-800-777-5331 FOR CUSTOMER SERVICE.

PROBLEM	POSSIBLE CAUSE	REMEDY
THE UNIT WILL NOT PLAY	• THE UNIT IS DISCONNECTED FROM THE AC OUTLET	• CONNECT TO AN OUTLET.
	• THE AC OUTLET HAS NO POWER	• TRY THE UNIT ON ANOTHER OUTLET
POOR AM OR FM RECEPTION	• WEAK SIGNAL ON DISTANT STATIONS	• ROTATE THE CABINET FOR BETTER RECEPTION
UNIT ON BUT THERE IS LOW OR NO VOLUME	• THE VOLUME CONTROL HAS BEEN TURNED ALL THE WAY DOWN	• TURN THE VOLUME CONTROL TO A HIGHER OUTPUT

**90 DAY LIMITED WARRANTY AND SERVICE
VALID IN THE U.S.A ONLY**

SPECTRA MERCHANDISING INTERNATIONAL, INC. warrants this unit to be free from defective materials or factory workmanship for a period of 90 days from the date of original customer purchase and provided the product is utilized within the U.S.A. This warranty is not assignable or transferable. Our obligation under this warranty is the repair or replacement of the defective unit or any part thereof, except batteries, when it is returned to the SPECTRA Service Department, accompanied by proof of the date of original consumer purchase, such as a duplicate copy of a sales receipt.

You must pay all shipping charges required to ship the product to SPECTRA for warranty service. If the product is repaired or replaced under warranty, the return charges will be at SPECTRA's expense. There are no other express warranties other than those stated herein.

This warranty is valid only in accordance with the conditions set forth below:

1. The warranty applies to the SPECTRA product only while:
 - a. It remains in the possession of the original purchaser and proof of purchase is demonstrated
 - b. It has not been subjected to accident, misuse, abuse, improper service, usage outside the descriptions and warnings covered within the owner's manual or non-SPECTRA approved modifications
 - c. Claims are made within the warranty period
2. This warranty does not cover damage or equipment failure caused by electrical wiring not in compliance with electrical codes or SPECTRA owner's manual specifications, or failure to provide reasonable care and necessary maintenance as outlined in the owner's manual.
3. Warranty of all SPECTRA products applies to residential use only and is void when products are used in a nonresidential environment or installed outside the United States.

This warranty gives you specific legal rights, and you may also have other rights which vary from state to state. TO OBTAIN SERVICE please remove all batteries (if any) and pack the unit carefully and send it freight prepaid to SPECTRA at the address shown below. IF THE UNIT IS RETURNED WITHIN THE WARRANTY PERIOD shown above, please include a proof of purchase (dated cash register receipt) so that we may establish your eligibility for warranty service and repair of the unit without cost. Also include a note with a description explaining how the unit is defective. A customer service representative may need to contact you regarding the status of your repair, so please include your name, address, phone number and email address to speed the process.

IF THE UNIT IS OUTSIDE THE WARRANTY PERIOD, please include a check for **\$45.00** to cover the cost of repair, handling and return postage. All out of warranty returns must be sent prepaid.

It is recommended that you contact SPECTRA first at 1-800-777-5331 or by email at custserv@spectraintl.com for updated information on the unit requiring service. In some cases the model you have may be discontinued, and SPECTRA reserves the right to offer alternative options for repair or replacement.

SPECTRA MERCHANDISING INTERNATIONAL, INC.
4230 North Normandy Avenue,
Chicago, IL60634, USA.
1-800-777-5331

To register your product, visit the link below to enter your information.
<http://www.spectraintl.com/wform.htm>

Printed in China