



**JMC-255**

## **CD MP3 MICRO SYSTEM**



## **INSTRUCTION MANUAL**

Please read this Instruction Manual carefully before using the unit and retain it for future reference

## WARNING

TO PREVENT FIRE OR SHOCK HAZARD, DO NOT USE THIS PLUG WITH AN EXTENSION CORD, RECEPTACLE OR OTHER OUTLET UNLESS THE BLADES CAN BE FULLY INSERTED TO PREVENT BLADE EXPOSURE. TO PREVENT FIRE OR SHOCK HAZARD, DO NOT EXPOSE THIS APPLIANCE TO RAIN OR MOISTURE.



The Caution Marking is located at the bottom enclosure of the apparatus.

## IMPORTANT SAFETY INSTRUCTIONS

1. Read these instructions.
2. Keep these instructions.
3. Heed all warnings.
4. Follow all instructions.
5. Do not use this apparatus near water.
6. Cleaning-Unplug this product from the wall outlet before cleaning. Do not use liquid cleaners or aerosol cleaners. **Clean only with dry cloth.**
7. Do not block any ventilation openings. Install in accordance with the manufacturer's instructions.
8. Do not place this product on an unstable cart, stand, tripod, bracket, or table. The product may fall, causing serious injury to a child or adult, and serious damage to the product. Use only with a cart, stand, tripod, bracket, or table recommended by the manufacturer, or sold with the product. Any mounting of the product should follow the manufacturer's instructions, and should use a mounting accessory recommended by the manufacturer. A product and cart combination should be moved with care-quick stops, excessive force and uneven surfaces may cause the product and cart combination to overturn.
9. Do not install near any heat sources such as radiators, heat registers, stoves, or other apparatus (including amplifiers) that product heat.
10. Do not defeat the safety purpose of the polarized or grounding-type plug. A polarized plug has two blades with one wider than the other. A grounding type plug has two blades and a third grounding prong. The wide blade or the third prong is provided for your safety. If the provided plug does not fit into your outlet, consult an electrician for replacement of the obsolete outlet.
11. Protect the power cord from being walked on or pinched particularly at plugs, convenience receptacles, and the point where they exit from the apparatus.
12. Only use attachments/accessories specified by the manufacturer.



13. Unplug this apparatus during lightening storms or when unused for a long periods of time.
14. Refer all servicing to qualified service personnel. Servicing is required when the apparatus has been damaged in any way, such as power-supply cord or plug is damaged, liquid has been spilled or objects have fallen into the apparatus, the apparatus has been exposed to rain or moisture, does not operate normally, or has been dropped.
15. This appliance shall not be exposed to dripping or splashing water and that no object filled with liquids such as vases shall be placed on the apparatus.
16. Do not overload wall outlet. Use only power source as indicated.
17. Use replacement part as specified by the manufacturer.
18. The product may be mounted to a wall only if recommended by the manufacturer.
19. Upon completion of any service or repairs to this product, ask the service technician to perform safety checks.
20. Power Sources - This product should be operated only from the type of power source indicated on the marking label. If you are not sure of the type of power supply to your home, consult your product dealer or local power company. For products intended to operate from battery power, or other sources, refer to the operating instruction.
21. Object and Liquid Entry - Never push objects of any kind into this product through openings as they may touch dangerous voltage points or short-out parts that could result in a fire or electric shock. Never spill liquid of any kind on the product.
22. Damage Requiring Service - Unplug this product from the wall outlet and refer servicing to qualified service personnel under the following conditions:
  - a) When the power-supply cord or plug is damaged,
  - b) If liquid has been spilled, or objects have fallen into the product,
  - c) If the product has been exposed to rain or water,
  - d) If the product does not operate normally by following the operating instructions. Adjust only those controls that are covered by the operating instructions as an improper adjustment of other controls may result in damage and will often require extensive work by a qualified technician to restore the product to its normal operation.
  - e) If the product has been dropped or damaged in any way, and
  - f) When the product exhibits a distinct change in performance - this indicates a need for service.

**CAUTION:**  
**TO PREVENT ELECTRIC SHOCK,**  
**MATCH WIDE BLADE OF PLUG TO WIDE SLOT.**  
**FULLY INSERT.**

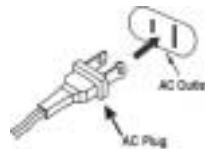

## CAUTION

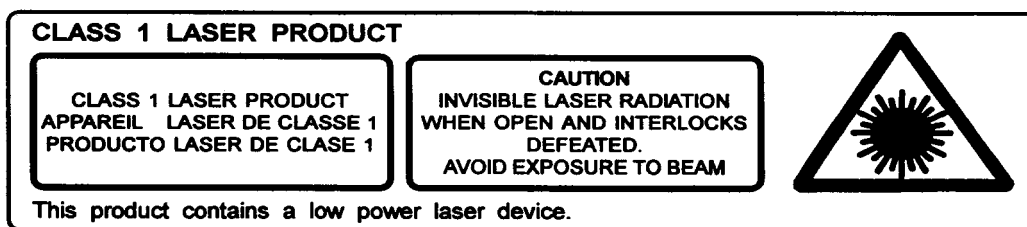

Follow the advice below for safe operations.

### ON PROTECTION AGAINST LASER ENERGY EXPOSURE

- As the laser beam used in this compact disc player is harmful to the eyes, do not attempt to disassemble the casing.
- Stop operation immediately if any liquid or solid object should fall into the cabinet.
- Do not touch the lens or poke at it. If you do, you may damage the lens and the player may not operate properly.
- Do not put anything in the safety slot. If you do, the laser diode will be ON when the CD door is still open.
- If the unit is not to be used for a long period of time, make sure that all power sources are disconnected from the unit. Remove all batteries from the battery compartment.
- This unit employs a laser. The use of controls or adjustment or performance of procedures other than those specified here may result in exposure to hazardous radiation.

Should any trouble occur, remove the power source and refer servicing to qualified personnel.

## COMPLIANCE WITH FCC REGULATIONS

This equipment has been tested and found to comply with the limits for a Class B Digital Device, pursuant to Part 15 of the FCC Rules. These limits are designed to provide reasonable protection against harmful interference in a residential installation. This equipment generates, uses and can radiate radio frequency energy and, if not installed and used in accordance with the instructions, may cause harmful interference to radio communications. However, there is no guarantee that interference will not occur in a particular installation. If this equipment does cause harmful interference to radio or television reception, which can be determined by turning the equipment off and on, the user is encouraged to try to correct the interference by one or more of the following measures:

- Reorient or relocate the receiving antenna.
- Increase the separation between the equipment and receiver.
- Connect the equipment into an outlet on a circuit different from that to which the receiver is connected.
- Consult the dealer or an experienced radio technician for help.

### WARNING:

Changes or modifications to this unit not expressly approved by the party responsible for compliance could void the user's authority to operate the equipment.

## LOCATION OF CONTROLS

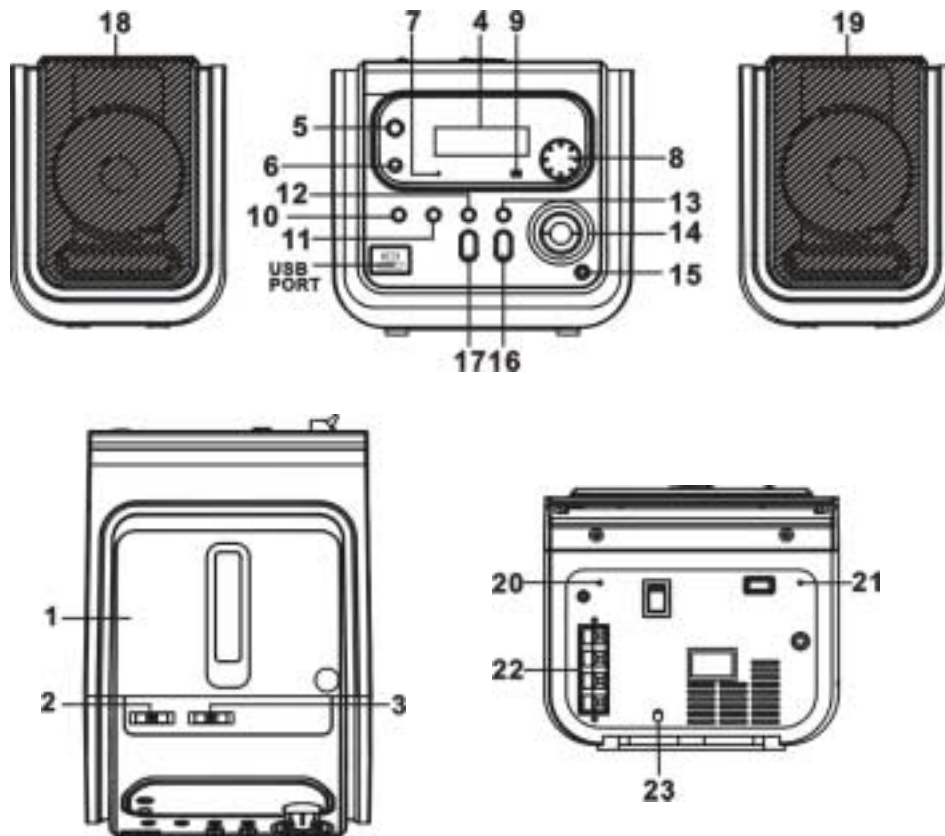

- |   |  |
|---|--|
| <ol style="list-style-type: none"> <li>1. CD DOOR</li> <li>2. FUNCTION SWITCH (AUX/CD/RADIO)</li> <li>3. BAND SWITCH (AM/FM/FM ST.)</li> <li>4. LCD DISPLAY</li> <li>5. POWER BUTTON (ON/OFF)</li> <li>6. BASS BOOST BUTTON</li> <li>7. STANDBY LED INDICATOR</li> <li>8. TUNING KNOB</li> <li>9. REMOTE SENSOR</li> <li>10. CD PROGRAM BUTTON</li> <li>11. CD MODE BUTTON</li> <li>12. CD STOP BUTTON ■</li> </ol> | <ol style="list-style-type: none"> <li>13. CD PLAY/PAUSE BUTTON ▶   </li> <li>14. VOLUME CONTROL (UP/DOWN)</li> <li>15. STEREO HEADPHONE JACK</li> <li>16. FOLDER – CD/USB BUTTON</li> <li>17. CD SKIP/SEARCH BUTTON (◀◀ BACKWARD/ ▶▶ FORWARD)</li> <li>18. SPEAKER LEFT</li> <li>19. SPEAKER RIGHT</li> <li>20. AUX IN JACK</li> <li>21. FM ANTENNA</li> <li>22. SPEAKER TERMINAL (L/R)</li> <li>23. AC POWER CORD</li> </ol> |
|---|--|

## IMPORTANT NOTES

Avoid installing the unit in locations described below:

- Places exposed to direct sunlight or close to heat radiating appliances such as electric heaters.
- Dusty places.
- Places subject to constant vibration.
- Humid or moist places.

## SPEAKER BOX CONNECTION

1. Insert the speaker cables by pushing down on the Red and Black terminal levers located on the back of the main unit.
2. Connect the left speaker wires to the Left Speaker Terminals. Connect the Red wire to L+ (positive) and the black wire to L- (negative).
3. Connect the right speaker wires to the Right Speaker Terminals. Connect the Red wire to R+ (positive) and the black wire to R- (negative).

## POWER SOURCE

This radio is designed to only operate on normal 120V AC ~ 60Hz power. Do not attempt to operate the radio on any other power source. You could cause damage to the radio and void your warranty.

The remote control unit operates on 2 x "AAA" (UM-4) size batteries (Not included).

Please be sure the outlet you plug this unit into is working and receives constant (unswitched) power.

## AC OPERATION

1. Plug the AC POWER CORD into a 120V AC ~ 60Hz outlet. The STANDBY LED INDICATOR will light up.
2. Press the POWER BUTTON to turn the unit On.  
The LCD DISPLAY will light and the STANDBY LED INDICATOR will go "Off".

### Remarks:

In case of malfunction due to electrostatic discharge (ESD), reset the unit by reconnecting the AC CORD again to resume to normal operation.

## INSERTING BATTERIES INTO THE REMOTE CONTROL

1. Turn over the remote control, and remove the battery door.

2. Install 2 x "AAA" (UM-4) size batteries (not included) according to the polarity diagram inside the battery compartment.
3. Close the battery door.
- 4.

**IMPORTANT:** Be sure that the batteries are installed correctly.

Wrong polarity may damage the unit and void the warranty.

**Note:** For best performance and longer operating time, we recommend the use of alkaline-type batteries.

### **BATTERY CARE**

- i. Do not mix old and new batteries.
- ii. Do not mix alkaline, standard (carbon-zinc) or rechargeable (nickel-cadmium) batteries.
- iii. If the unit is not to be used for an extended period of time, remove the battery. Old or leaking battery can cause damage to the unit and may void the warranty.
- iv. Do not dispose of batteries in fire, batteries may explode or leak.

### **BATTERY REPLACEMENT**

The operating distance of the Remote Control is greatly reduced and becomes intermittent when the batteries are weak. You need to replace both of the batteries when these conditions occur.

## USING THE REMOTE CONTROL CORRECTLY

- Point the Remote Control at the REMOTE SENSOR located on the main unit.
- The button functions are the same as the corresponding controls on the main unit.
- Bright ambient light sources can cause interference when using the infrared REMOTE SENSOR.
- The recommended effective distance for remote operation is about 15 feet.

### 24. POWER BUTTON

- With the main unit power ON, press the POWER BUTTON once, the unit will go into Standby Mode and the STANDBY LED INDICATOR on the main unit will light.
- Press the POWER BUTTON again and the main unit will turn on and resume normal play function.

### 25. PLAY/PAUSE BUTTON

Press to start play or pause the CD (CD MODE).

### 26. STOP BUTTON

Press to stop CD play.

### 27+28. FOLDER "◀ DOWN" / "▶ UP" (MP3 CD)

- Press once to show the Folder number.
- Press twice to change the Folder number downward or upward.

### 29+30. SKIP/SEARCH "◀◀ / ▶▶"

Skip or Search Backward / Forward for the desired track or passage in CD mode.

### 31. MUTE BUTTON

Press to silence the sound output.

### 32. MODE BUTTON

Press in sequence for different play modes.

Playing CD DISC : Repeat 1 → Repeat All → Random Play → Normal Play.

Playing MP3 DISC : Repeat 1 → Repeat Folder → Repeat All → Random Play → Normal Play.

### 33. VOLUME (Up ▲ or Down ▼)

Press to adjust the volume

### 34. BATTERY DOOR

Slide open the BATTERY DOOR, then insert two "AAA" size (UM-4) batteries according to the polarity diagram inside the battery compartment.

### 35. INFRARED TRANSMITTER.

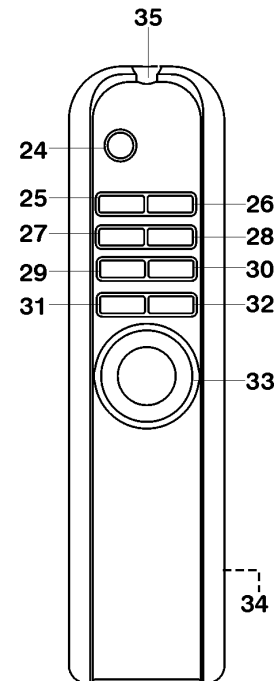

## NOTE:

If the Remote Controller is not to be used for a long time, remove the batteries to prevent possible damage from the batteries.

Do not mix different types of batteries or old batteries with new ones.



## RADIO OPERATION

1. Slide the FUNCTION SWITCH to the "RADIO" position.
2. Slide the BAND SWITCH to your desired band (AM, FM or FM ST.).
3. Turn the TUNING KNOB to your desired radio station. The radio frequency appears in the LCD DISPLAY.
4. Adjust the sound level by pressing the VOLUME buttons (Up/Down).
5. To turn off the radio, press the POWER BUTTON once. The LCD DISPLAY will go "off" and the STANDBY LED INDICATOR will light.

## FM STEREO RECEPTION

With the BAND SWITCH in the "FM ST" position, the FM Stereo Indicator "((ST))" will light up when listening to a strong station that is broadcasting in "Stereo".

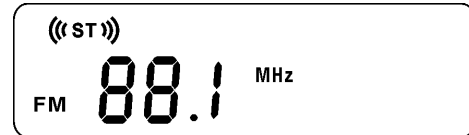

When the FM stereo reception is weak, slide the BAND SWITCH to FM position. The reception may be improved, but the sound is monaural (MONO).

## TIPS FOR BEST RECEPTION

- AM – The AM antenna is located inside the cabinet of the main unit. If AM reception is weak, change the position of cabinet until the internal antenna picks up the strongest signal,
- FM – During FM reception, always keep the FM Wire Antenna fully extended. If FM reception is weak try repositioning the FM Wire Antenna until you find the strongest signal.

## BASS BOOST

To enhance the low frequency sound, press the BASS BOOST BUTTON "ON" (a "click" will be heard). To release the BASS BOOST, press this button once again (two "clicks" will be heard).

## AUXILIARY (AUX) OPERATION

You can play other music sources (MP3 player or other digital audio player) through the speakers of this system by connecting the AUX IN Jack to your external player's audio out jack or headphone jack.

1. Plug one end of an audio cable (not included) into the AUX IN Jack and the other end of the cable to the headphone jack of your digital audio player.
2. Set the FUNCTION SWITCH to the "AUX" position.
3. Press the POWER BUTTON to turn on the system
4. Play your digital audio player.
5. Press the VOLUME CONTROL BUTTON until you reach a comfortable listening level.

## CD OPERATION

THIS PLAYER PLAYS NOT ONLY COMMERCIAL CD'S BUT ALSO CD-RW DISCS.

- Because of non-standardized format definition/production of CD-R/RW, playback quality & performance are not guaranteed.
- Manufacturer is not responsible for the playability of CD-R/RW due to recording conditions such as PC performance, writing software, media ability, etc.
- Do not attach a label or seal to either side of the CD-R/RW disc. It may cause a malfunction.

**Note:** If skipping occurs during CD playing, try turning the volume down.  
Do not open the CD DOOR when CD is playing.

1. Open the CD DOOR by pressing the CD DOOR at the "PUSH OPEN" mark located on the CD door.
2. Insert a CD disc into the CD Compartment with the label facing up and close the CD DOOR.

**Note:** Ensure the CD DOOR is closed properly and locked in place.

3. Set the FUNCTION SWITCH to the "CD" position.
4. Press the POWER BUTTON once. The Player will start reading the CD. The total number of tracks on the disc will be shown in the LCD DISPLAY after a few seconds.

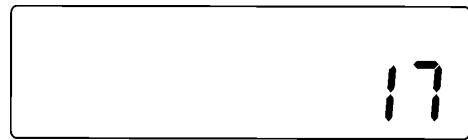

**Note:**

- i. If there is no disc inside, "no" will be shown in the LCD DISPLAY.
- ii. If the CD DOOR is not closed, the LCD DISPLAY will show "- - -".



### Play/Pause Mode

5. When the PLAY/PAUSE ▶ II BUTTON is pressed during CD stop mode, the first track will be played. The Play Indicator "▶" will be shown in the LCD DISPLAY. The LCD DISPLAY will show the specific number of track being played.

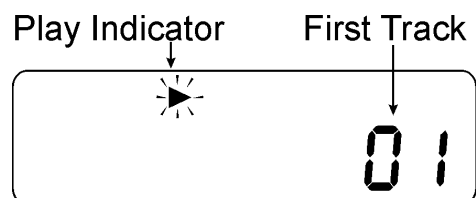
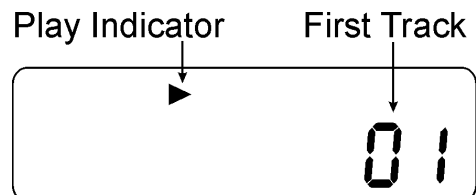

6. To pause the CD playback, press the CD PLAY/PAUSE ►|| BUTTON once. The Play Indicator “►” will blink continuously on the LCD DISPLAY.
7. Though the sound stops, the disc will continue to spin. To resume playing, press the CD PLAY/PAUSE ►|| BUTTON once again. The music will start from the exact position where it was paused.

### Skip And Search Mode

8. In play or pause mode, when the CD SKIP/SEARCH FORWARD ►► or BACKWARD ◄◄ BUTTON is pressed once, the player will go to play the next track or go back to the beginning of the current track.
9. In play mode, when the CD SKIP/SEARCH FORWARD ►► or BACKWARD ◄◄ BUTTON is pressed and held, the player will search the track with an audible high-speed forward or backward playback.

### Repeat Play Mode

10. Repeat 1 :  
When the MODE BUTTON is pressed once, the “Repeat” Indicator will be shown on the LCD DISPLAY. This single track of music will be played repeatedly.

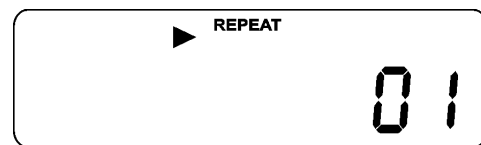

11. Repeat All:  
When the MODE BUTTON is pressed twice, the “Repeat All” Indicator will be shown on the LCD DISPLAY. The whole disc will be played continuously.

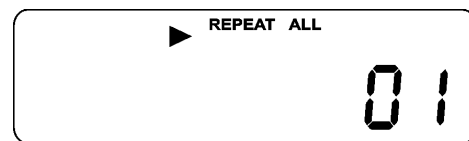

12. To cancel the repeat function, press the MODE BUTTON repeatedly until the Repeat Indicator disappears from the LCD DISPLAY.

### Random Play Mode

This feature allows the track on the disc to be played in a random order.

13. In CD stop mode, press the MODE BUTTON three times, the “RANDOM” indicator will appear on the LCD DISPLAY. Press the PLAY/PAUSE ►|| BUTTON once to start the playback.



14. To cancel the random play function, press the MODE BUTTON again, “RANDOM” Indicator will disappear from the LCD DISPLAY.

- To stop the CD, press the CD STOP BUTTON once no matter the CD is in Play or Pause mode. The LCD DISPLAY will show the total number of tracks of the disc again.
- To turn off the unit, press the POWER BUTTON once.

**PROGRAMMED PLAY**

- In CD stop mode, press the PROGRAM BUTTON once. The program Indicator "PROGRAM" and the Program No. "P01" will light up and blink continuously to prompt for input.

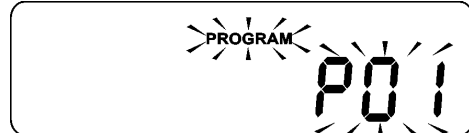

**Note:** The Player will exit the Program mode if there is no input in 30 seconds.

- Press the CD SKIP/SEARCH FORWARD ►► or BACKWARD ◄◄ BUTTON to select your desired musical track.

- Press the PROGRAM BUTTON to store the track in memory when your desired track number appears on the DISPLAY. The Program No. will change to "P 02" and blink to prompt for another input.

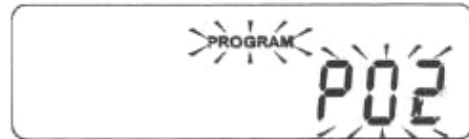

- Repeat above procedure until all desired tracks have been programmed. You can program up to 20 tracks in the program memory.

**Remarks:**

Whenever the CD SKIP/SEARCH FORWARD ►► or BACKWARD ◄◄ BUTTON is pressed during programming the CD Track, the LCD Display will always show the last programmed track first to recall your memory. After complete programming, the LCD DISPLAY will show "PROG. \_ \_ \_" and flash continuously.

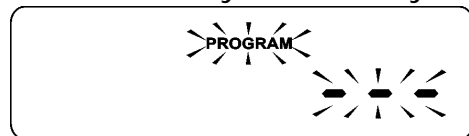

- Press the CD PLAY/PAUSE ► || BUTTON once to start the program playback in your programmed sequence. The CD Play Indicator "►" will light up. The Player will stop playback automatically when all the programmed tracks has been played.

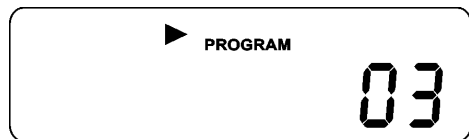

- To check the programs you have stored in memory, press the PROGRAM

BUTTON once in CD stop mode, Program No. "001" will light up and blink then press the CD SKIP/SEARCH FORWARD BUTTON to view the programmed track.

7. Repeat the procedure in step 6 above to view the rest of the programmed tracks one by one.
8. To cancel the programmed memory :
  - i. Press the CD STOP ■ BUTTON once in CD stop mode.,  
OR
  - ii. Open the CD DOOR in CD stop mode.

The "PROGRAM" Indicator will disappear from the LCD DISPLAY.

### PLAYING MP3 DISCS

**Note:**

- i. If skipping occurs during MP3 Disc playing, try turning the volume down.
- ii. When MP3 disc is playing, do not open the CD DOOR.

1. Open the CD DOOR by pressing the CD DOOR at the "PUSH OPEN" mark located on the CD door.
2. Insert an MP3 Disc into the CD Compartment with the label or print side facing up and close the CD DOOR.

**Note:** Ensure the CD DOOR is closed properly and locked in place.

3. Set the FUNCTION SWITCH to "CD" position.
4. Press the POWER BUTTON once.

The Player will start reading the CD. The total number of tracks on the disc will be shown in the LCD DISPLAY after a while.

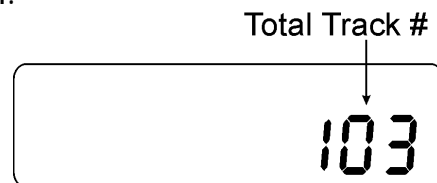

**Note:**

- i. If there is no disc inside, "NO" will be shown on the LCD DISPLAY.
- ii. If the CD DOOR is not closed, the DISPLAY will show " - - - ".

### Play/Pause Mode

5. When the PLAY/PAUSE ► || BUTTON is pressed during CD stop mode, the first track will be played. The Play Indicator " ► " will light up. The "MP3" Indicator will appear as well indicating that an MP3 Disc is being played. The LCD DISPLAY will show the specific track number being played.



6. To select the specific musical tracks inside the MP3 Disc.

MP3 music can be stored into the CD Disc with or without folders according to your "MP3 burning method".

- a. If the MP3 disc is created without dividing into folder, all track number will be shown directly on the LCD DISPLAY. The Album number e.g. 001 will only appear briefly on the LCD DISPLAY after pressing the FOLDER UP ► or DOWN ◀ BUTTON.

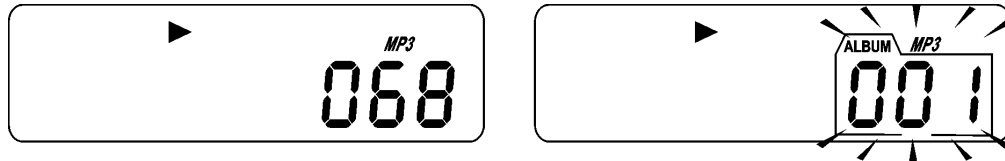

- b. If the music is stored in different folders, then you must select the specific Album number first by pressing the FOLDER UP ► or DOWN ◀ BUTTON ; afterwards press the CD SKIP/SEARCH FORWARD ►► or BACKWARD ◀◀ BUTTON to select the specific Track number located inside this Album.

c.

**Example :** To select Album # 4, track # 3.

STEP – 1 : Press the FOLDER UP ► or DOWN ◀ BUTTON to select the Album # 4.

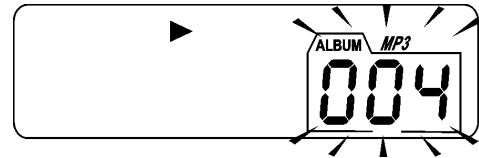

STEP – 2 : Press the CD SKIP/SEARCH FORWARD ►► or BACKWARD ◀◀ BUTTON to select the Track # 3 inside this Album # 4.



7. To pause the MP3 Disc playback, press the CD PLAY/PAUSE ► || BUTTON once. The Play Indicator " ► " will blink continuously on the LCD DISPLAY.
8. Though the sound stops, the disc will continue to spin. To resume playing, press the CD PLAY/PAUSE ► || BUTTON once again. The music will start from the exact position where it was paused.

### Repeat Mode

9. Repeat 1 :

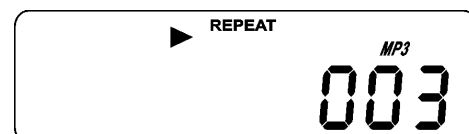

When the MODE BUTTON is pressed once, the "REPEAT" Indicator will light. This single track of music will be repeated.

10. Repeat Folder :

When the MODE BUTTON is pressed twice, the "REPEAT" and "ALBUM" indicators will be shown. This specific folder will be played repeatedly.

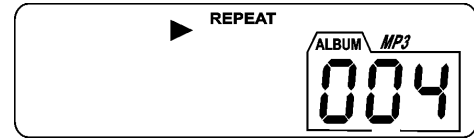

11. Repeat All :

When the REPEAT BUTTON is pressed three times, the "REPEAT ALL" Indicator will be shown. The whole disc can be played continuously.

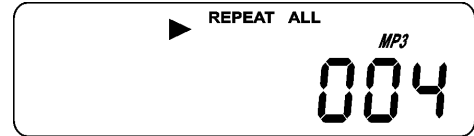

12. To cancel the Repeat Function

Press the MODE BUTTON repeatedly until the Repeat Indicator disappears from the LCD DISPLAY.

### Skip And Search Mode

13. During play or pause mode, when CD SKIP/SEARCH FORWARD ►► or BACKWARD ◀◀ BUTTON is pressed once, it will go to the next track or go back to the beginning of the track.

14. During play mode, when CD SKIP/SEARCH FORWARD ►► or BACKWARD ◀◀ BUTTON is pressed once and held, it will search the track with audible high speed forward or backward playback.

### Random Play Mode

This feature allows the tracks on the disc to be played in a random order.

15. During the CD Stop mode, press the MODE BUTTON four times, the "RANDOM" Indicator will show on the LCD DISPLAY. Press the PLAY/PAUSE ► || BUTTON once to start the playback.



16. To cancel the Random Play function, press the MODE BUTTON again, "RANDOM" Indicator will disappear from the LCD DISPLAY.

17. To stop the MP3 disc, press the CD STOP BUTTON once whether the MP3 disc is in Play or Pause mode.

18. To turn off the unit, press the POWER BUTTON once.

### MP3 PROGRAMMED PLAY

1. In CD stop mode, press the PROGRAM BUTTON once. The "PROGRAM" Indicator and the number of Program to be memorized starts from the

first program "P01" will light up and blink continuously. Press the FOLDER UP ► or DOWN ◀ BUTTON and then press CD SKIP/SEARCH FORWARD ►► or BACKWARD ◀◀ BUTTON to select your desired music track. The LCD DISPLAY will show the track number of this specific Album to be programmed. Press the PROGRAM BUTTON to store this track in memory.

- Repeat above procedure until all desired tracks have been programmed.

**Remarks:** Whenever the FOLDER UP ► or DOWN ◀ BUTTON is pressed, it will always show the last programmed Album number first to recall your memory.

A total of 20 tracks can be stored in memory. After completion of the programming of all the 20 tracks, the LCD DISPLAY will show "PROG. \_ \_ \_" and blink continuously.

- To start the Programmed playback, press the CD PLAY/PAUSE ► || BUTTON once and the CD Play Indicator "►", "PROGRAM", "MP3" Indicator and the track number of the specific Album will light up.
- To check the program you have stored after programming, press the PROGRAM Button once. "PROGRAM" and Program No. "P01" will light up and blink.
- Press the CD SKIP/SEARCH FORWARD ►► BUTTON to view the programmed track of the Album and then press FOLDER UP ► or DOWN ◀ Button to view the Album number.

**Example :** Album # 3, Track # 2.

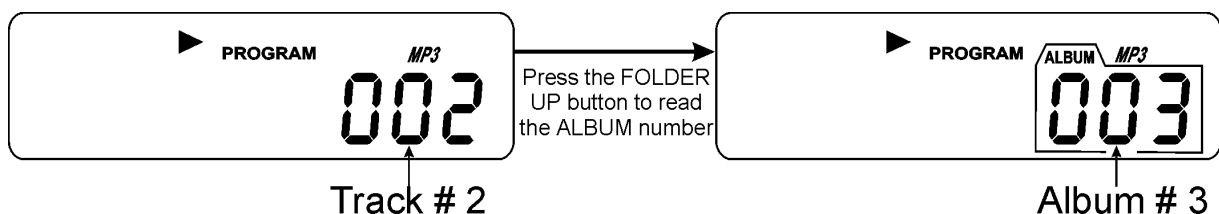

- Repeat the procedure in steps 3 & 4 above to view the rest of the programmed track and Album one by one.
- To cancel the programmed memory :
  - During CD stop mode, press the CD STOP ■ BUTTON once.
  - OR
  - Open the CD Door during CD stop mode.
 The "PROGRAM" Indicator will disappear from the LCD DISPLAY.

### USB OPERATION

- Slide the FUNCTION SWITCH to "CD".

**NOTE:** Make sure no disc is located inside the CD compartment.



2. Insert the USB plug of an Auxiliary device (e.g.: Portable MP3 Player or Flash Drive) into the USB PORT located on the front of this unit, The LCD DISPLAY will show "no".



3. Press the CD/USB Button (#16) once, "USB" Indicator will be shown in the LCD DISPLAY. Afterwards, the total number of music on the player or drive will be shown as well.

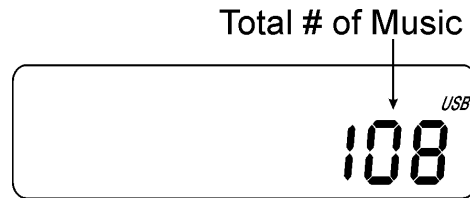

4. Press the CD PLAY/PAUSE ► || BUTTON again to start playing the music.
5. USB playback operates the same way as mentioned in above section "PLAYING MP3 DISC", they share all the same function and operation methods as an MP3 Disc.
6. To exit from the USB playback mode, press and hold the CD/USB Button again, the "USB" Indicator will disappear from the LCD DISPLAY.

### **IMPORTANT:**

**Because there are so many different MP3 file types in the market today, this unit might not support all of the formats available due to the changing encoding methods.**

### **USING HEADPHONES (NOT INCLUDED)**

Inserting the plug of your headphones into the Headphone jack will enable you to listen in private. When using headphones, the speakers will be disconnected automatically.

### **READ THIS IMPORTANT INFORMATION BEFORE USING YOUR HEADPHONES**

1. Avoid extended play at very high volume as it may impair your hearing.
2. If you experience ringing in your ears, reduce the volume or shut off your unit.
3. Keep the volume at a reasonable level even if your headset is an open-air type designed to allow you to hear outside sounds. Please note that excessively high volume may still block outside sounds.

### **CARE AND MAINTENANCE**

1. Children should be supervised when using this appliance.

2. Never wrap the earphone lead around any animal or person. Special care should be taken with long wires.
3. Clean your unit with a damp (never wet) cloth. Solvent or detergent should never be used.
4. Avoid leaving your unit in direct sunlight or in hot, humid or dusty places.
5. Keep your unit away from heating appliances and sources of electrical noise such as fluorescent lamps or motors.
6. If drop-outs or interruptions occur in the music during CD play, or if the CD fails to play at all, its bottom surface may require cleaning. Before playing, wipe the disc from the center outwards with a good soft cleaning cloth.



## TROUBLE SHOOTING GUIDE

If you experience difficulties in the use of this music system please check the following or call **1 800 777 5331** for Customer Service and Support.

Symptom	Possible Cause	Solution
Noise or sound distorted on AM or FM broadcast	Station not tuned properly for AM or FM. FM: Wire antenna is not extended. AM: The bar antenna is not positioned correctly	Retune the AM or FM broadcast station. FM: Extend FM Wire antenna. AM: Reposition the unit until the best reception is obtained.
AM or FM no sound	Unit not in RADIO function mode. Volume set at minimum	Slide Function Selector to RADIO position Increase Volume
CD player will not play	Unit not in CD function mode. CD is installed incorrectly. If the CD is self-compiled, the media used may not be compatible with the player.	Select CD function mode. Insert CD with label side up. Use better quality blank media and retest.
CD skips while playing	Disc is dirty or scratched.	Wipe CD with clean cloth or use another disc.
Intermittent sound from CD Player	Dirty or defective disc Dirty pick up lens Player is subject to excessive shock or vibration	Clean or replace the defective disc Use a CD-lens cleaning disc to clean the lens Relocate the player away from shock or vibration
No sound when played in the AUX Mode	Power to external source (CD, MP3 etc) not switched on Connection to external source (CD, MP3 etc) is incorrect: e.g. RCA plug may have been inserted to AUDIO IN of external source. Master Volume is at minimum.	Switch on the power of the external source. Reconnect the RCA Plug to the AUDIO OUT of the external source. Adjust the master volume

## SERVICE

Please refer to the instructions on the enclosed warranty card for returning your unit for service. When returning the unit, please remove any batteries to prevent damage to the unit in transit and/or from possible battery leakage. We are not responsible for batteries returned with the product or for the cost of replacement.

Distributed by:

Spectra Merchandising International, Inc.

4230 North Normandy Avenue

Chicago, IL 60634, U.S.A.

Please have model number ready, for Customer Service, call 1-800-777-5331

Printed in China