



---

AM/FM WEATHER BAND RADIO  
WITH WEATHER ALERT



**MODEL: JEP-650  
USER MANUAL**



PLEASE READ THIS USER MANUAL COMPLETELY BEFORE  
OPERATING THIS UNIT AND RETAIN IT FOR FUTURE REFERENCE

## IMPORTANT SAFETY INSTRUCTIONS

When used in the directed manner, this unit has been designed and manufactured to ensure your personal safety. However, improper use can result in potential electrical shock or fire hazards. Please read all safety and operating instructions carefully before installation and use, and keep these instructions handy for future reference. Take special note of all warnings listed in these instructions and on the unit.

1. Read these instructions – All the safety and operating instructions should be read before the appliance is operated.
2. Keep these instructions – The safety and operating instructions should be kept for future reference.
3. Heed all warnings – All warnings on the appliance and in the operating instructions should be adhered to.
4. Follow all instructions – All operation and use instructions should be followed.
5. Do not use this apparatus near water – The appliance should not be used near water; for example, near a bath tub, washbowl, kitchen sink, laundry tub, in a wet basement, or near a swimming pool.
6. Clean only with dry cloth – The appliance should be cleaned only as recommended by the manufacturer.
7. Do not install near any heat sources such as radiators, heat registers, stoves, or other apparatus (including amplifiers) that produce heat.
8. Only use attachments / accessories specified by the manufacturer.
9. Refer all servicing to qualified service personnel. Servicing is required when the apparatus has been damaged in any way, such as power-supply cord or plug is damaged, liquid has been spilled or objects have fallen into the apparatus, the apparatus has been exposed to rain or moisture, does not operate normally, or has been dropped.
10. This appliance shall not be exposed to dripping or splashing water and that no object filled with liquids such as vases shall be placed on the apparatus.
11. Power Sources – The appliance should be connected to a power supply only of the type described in the operating instructions or as marked on the appliance. Do not overload wall outlet.
12. Danger of explosion if battery is incorrectly replaced. Replace only with the same or equivalent type.
13. Do not attempt to dismantle, open or repair this product yourself. If a fault occurs, seek advice from your local qualified service technician or contact the distributor via the telephone number at the back of this instruction manual.
14. Caution marking and nameplate are located on back of product.

## COMPLIANCE WITH FCC REGULATIONS

This device complies with Part 15 of the FCC Rules. Operation is subject to the following two conditions:

- (1) this device may not cause harmful interference, and
- (2) this device must accept any interference received, including interference that may cause undesired operation.

NOTE: This equipment has been tested and found to comply with the limits for a Class B digital device, pursuant to Part 15 of the FCC Rules. These limits are designed to provide reasonable protection against harmful interference in a residential installation. This equipment generates, uses and can radiate radio frequency energy and, if not installed and used in accordance with the instructions, may cause harmful interference to radio communications. However, there is no guarantee that interference will not occur in a particular installation. If this equipment does cause harmful interference to radio or television reception, which can be determined by turning the equipment off and on, the user is encouraged to try to correct the interference by one or more of the following measures:

- Reorient or relocate the receiving antenna.
- Increase the separation between the equipment and receiver.
- Connect the equipment into an outlet on a circuit different from that to which the receiver is connected.
- Consult the dealer or an experienced radio/TV technician for help.

**CAUTION: Changes or modifications not expressly approved by the party responsible for compliance could void the user's authority to operate the equipment.**

## SPECIAL NOTE

To prevent any scratching or damage to your furniture, we strongly recommend that you purchase small self-adhesive felt pads, available at hardware stores and home improvement centers everywhere, and apply these pads to the bottom of the unit before you place the product on any fine wooden furniture.

## DEAR JENSEN® CUSTOMER

Selecting fine audio equipment such as the unit you've just purchased is only the start of your musical enjoyment. Now it's time to consider how you can maximize the fun and excitement your equipment offers. This manufacturer and the Electronic Industries Association's Consumer Electronics Group want you to get the most out of your equipment by playing it at a safe level. One that lets the sound come through loud and clear without annoying blaring or distortion and, most importantly, without affecting your sensitive hearing.

Sound can be deceiving. Over time your hearing "comfort level" adapts to higher volumes of sound. So what sounds "normal" can actually be loud and harmful to your hearing. Guard against this by setting your equipment at a safe level BEFORE your hearing adapts.

### To establish a safe level:

- Start your volume control at a low setting.
- Slowly increase the sound until you can hear it comfortably and clearly, and without distortion.

### Once you have established a comfortable sound level:

- Set the dial and leave it there.

Taking a minute to do this now will help to prevent hearing damage or loss in the future. After all, we want you listening for a lifetime.

### We Want You Listening For a Lifetime

Used wisely, your new sound equipment will provide a lifetime of fun and enjoyment. Since hearing damage from loud noise is often undetectable until it is too late, this manufacturer and the Electronic Industries Association's Consumer Electronics Group recommend you avoid prolonged exposure to excessive noise.



### Customer's Record:

The serial number of this product is found on its bottom cover. You should note the serial number of this unit in the space provided as a permanent record of your purchase to aid in identification in the event of theft or loss.

Model Number: JEP-650

Serial Number: \_\_\_\_\_

## LOCATION OF CONTROLS

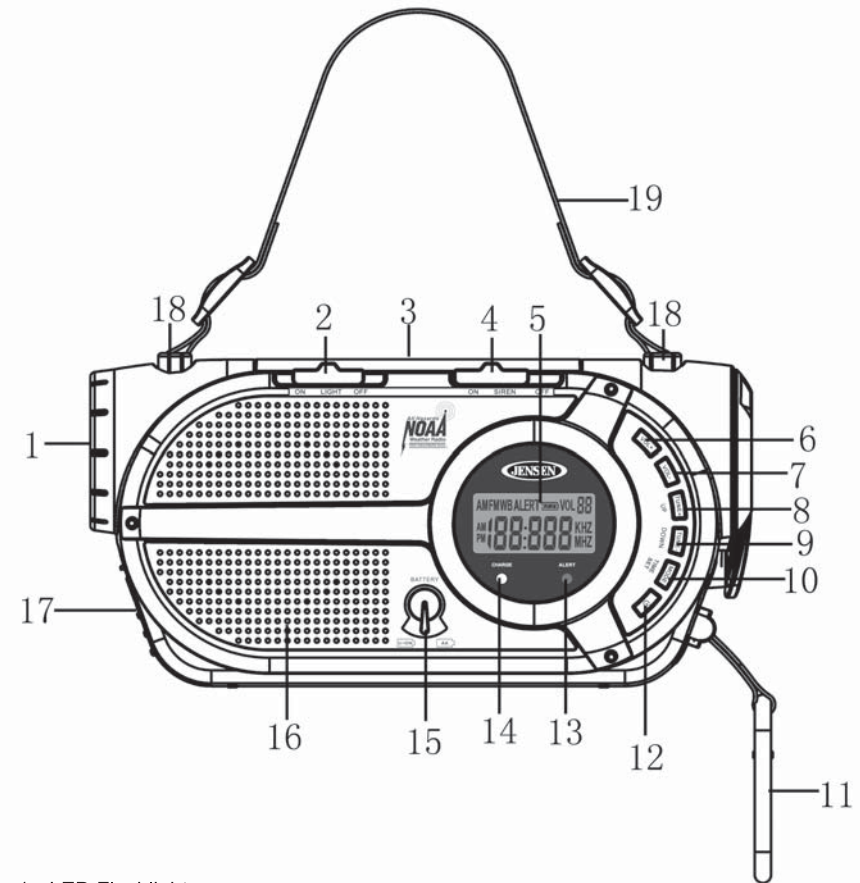

1. LED Flashlight
2. Flashlight ON/OFF Switch
3. Solar Panel
4. Siren ON/OFF Switch
5. LCD Display
6. Volume Up (+) Button
7. Volume Down (-) Button
8. Clock Adjust UP/Radio TUNE+ Button
9. Clock Adjust DOWN/Radio TUNE- Button
10. TIME SET/Radio Mode Selection Button
11. Carabineer with strap

- 12. Power On/Standby  Button
- 13. Weather Alert Indicator
- 14. Charging Indicator for Built-in Battery
- 15. Battery Selector Switch - Built-in Rechargeable (LI-ION) or "AA" (not included)
- 16. Speaker
- 17. Storage Compartment
- 18. Mounting Hole

- 19. Carrying Strap (not attached)
- 20. Rotary Telescopic Antenna
- 21. USB Charging Port
- 22. RESET Button
- 23. Hand Crank
- 24. Battery Compartment
- 25. Headphone Jack
- 26. Micro USB DC Input Port

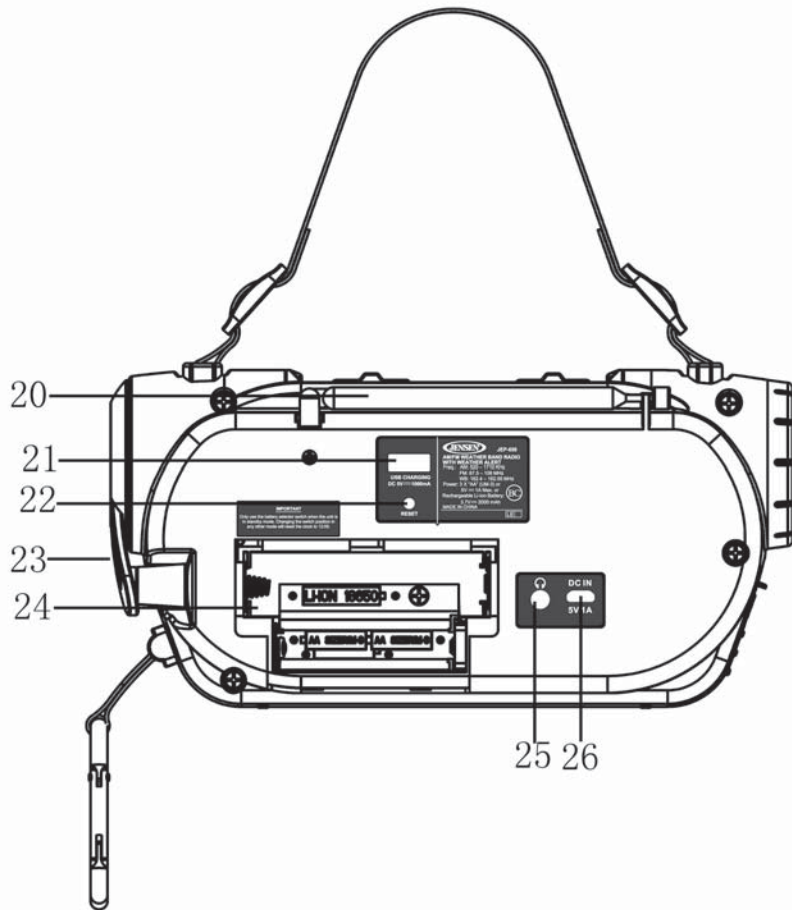

E5

## POWER SOURCE

This radio is designed to operate on multiple power sources.

**IMPORTANT:** Set the Battery Selector Switch in the Built-in Rechargeable "LI-ION"  position and pull the insulator tab from the battery compartment to activate the internal

rechargeable battery. If the low battery icon  appears flashing on the display, fully recharge the internal rechargeable battery using one of the options below, or install 3 new "AA" batteries and change the Battery Selector Switch to "AA" Battery mode.

### A) FOUR WAYS TO POWER THE UNIT

#### 1) "DYNAMO" POWER OPERATION

1. A 3.7V DC rechargeable lithium battery is included with the JEP-650 and comes pre-installed in the unit. To activate the battery, pull on the clear insulator tab to remove it from the battery compartment.
2. Set the Battery Selector Switch on the front panel to the "LI-ION"  position.
3. Lift the Hand Crank handle outward until it's fully extended. Begin rotating the Hand Crank either clockwise or counterclockwise to begin charging the internal battery. The red CHARGE LED on the front panel will light red while you are turning the Hand Crank.

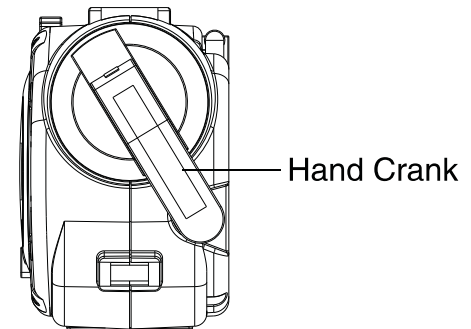

E6

- Continue turning the Crank to generate electricity to charge the battery. More power is generated the longer you turn the crank handle, and the Radio listening time will be extended (Radio reception only).

**Note:** Turn the Hand Crank continuously in a clockwise or counterclockwise direction at 100-130 RPM (1-2 complete turns per second) to generate constant power and charge the internal battery. It may require up to 5 - 6 minutes of cranking if the battery is completely drained and the LCD clock display and LED light do not work. You may need to press the reset button if lithium battery is charged up by cranking but radio or LED light does not work.

- Press the Power On/Standby  button to turn on the unit for operation.



#### Lithium Battery Safety Instructions

Do not burn or bury batteries. Do not puncture or crush. Do not disassemble.  
Recycle Lithium batteries. Do not dispose of in the trash.

If the electrolyte in the cells should get on your skin, thoroughly wash with soap and water.

If in the eyes, rinse thoroughly with cool water. Immediately seek medical attention.

Use only chargers rated for Lithium cells. Be sure the charger's voltage and current settings are correct for the battery pack being charged.

Charge batteries on a fireproof surface away from flammable items or liquids.

Batteries should NEVER be left unattended while charging. Only adults should charge the batteries.

Follow the manufacturer's instructions for charging the product and do not charge longer than recommended. Unplug the charger when the battery is charged.





#### Recycle Rechargeable Batteries

Recycle your old rechargeable batteries at one of the many collection sites in the U.S. and Canada. To find the site nearest you, visit [www.call2recycle.org](http://www.call2recycle.org) or call toll-free 1-877-2-RECYCLE.

#### 2) Dry cell Battery Operation

- Open the Battery Door on the back of the radio.
- Following the polarity diagrams shown in the battery compartment, insert 3 'AA' (UM-3) batteries (Not included) and close the battery door.

**Note:** For optimum performance, alkaline-type batteries are recommended.

- Set the Battery Selector Switch to the "AA Battery"  position. The build-in rechargeable lithium battery will be cut off.
- Press the Power On/Standby  button to turn on the unit for operation.

#### IMPORTANT:

- Be sure that the batteries are installed correctly. Wrong polarity may damage the unit.

- Only change the position of the Battery Selector Switch when the unit is in standby mode. Changing the position of the Battery Selector Switch in any other mode will reset the clock to 12:00.**

#### WARNING:

- Be sure that the batteries are installed correctly. Wrong polarity may damage the unit.
- Do not mix old and new batteries.
- Do not mix alkaline, standard (carbon-zinc) or rechargeable (nickel-cadmium) batteries.
- Only batteries of the same or equivalent type as recommend are to be used.
- If the unit is not to be used for an extended period of time, remove the battery. Any old or leaking battery can cause damage to the unit and may void the warranty.
- Do not dispose of batteries in fire, batteries may explode or leak.
- Do not try to recharge batteries not intended to be recharged; they can overheat, rupture and leak (Follow battery manufacturer's directions).

#### 3) SOLAR POWER

- Ensure the included rechargeable Li-ion Battery is installed.
- Set the Battery Selector Switch to "LI-ION"  position.
- Put the unit in direct sunlight, making sure the solar panel of the unit is facing towards the sun. If the sunlight is strong enough, the red CHARGE LED on the front panel of the unit will light up red indicating the unit is charging. More power is generated the longer you leave the unit in direct sunlight, and the Radio listening time will be extended (Radio reception only).

**Note:** If the battery is completely drained (LCD clock display and LED light do not work), it may require very long exposure to direct sunlight in order to charge the battery using the solar panel. You should use one of the other power modes available if you need to use the radio immediately.

#### 4) DC IN micro USB Charging Port

The unit has a micro USB port on the back of the unit.

- Use the micro USB plug side of a 5V DC, 1000mA output AC adaptor (not included), and connect it to the USB port on the back of the unit.
- Ensure the included rechargeable Li-ion Battery is installed and plug the AC adaptor into an 120V AC, 60Hz household outlet.
- Set the Battery Selector Switch to "LI-ION"  position.

**Note:** 1.) The USB power adaptor (not included) described above is the same type commonly used with smartphones. A USB to micro USB cord (not included) is also required for charging the unit via the micro USB jack located on the back of the unit.

2.) Make sure you have set the Battery Selector Switch in the "LI-ION"  position when using USB power. The unit will not work in the AA battery position if no AA batteries are installed or the installed batteries are drained.

3.) You may experience noise or reduced reception if you are operating the radio when using the Micro USB charging port. This interference is caused by the adaptor you are using and not a defect with the product. We recommend using another adaptor, preferably a linear type or refrain from using the radio until the internal battery is fully charged.

## LOW BATTERY INDICATOR

When using battery power to operate this unit and the battery power becomes weak, the low battery icon  will appear & flashing on LCD display. You are recommended to charge the rechargeable battery or replace the exhausted dry cell batteries immediately.

## CLOCK SETTING

When the unit is in standby mode:

### Setting 12/24 Hour format

1. Press and hold the MODE button for 2 seconds to enter clock setting mode, 12 hour format (12 Hr) flashing.  
**Note:** The digits will flash for 10 seconds and automatically confirm and stop flashing if no buttons are pressed within 10 seconds.
2. Tap the TUNE+ (UP) / TUNE- (DOWN) button to select 12 hour (12Hr) or 24 hour (24Hr) format, then press MODE button to confirm. Hour digits flashing to prompt for input.

### Setting Clock

3. Tap the TUNE+ (UP) / TUNE- (DOWN) button repeatedly to set the hour value. Press and hold the buttons to speed up the forward or reverse scanning of the digits.  
**Note:** Make sure the hour is set so that the **AM** or **PM** indicators are displayed correctly.
4. Press the MODE button after the hour is set, Minute digits flashing to prompt for input.
5. Tap the TUNE+ (UP) / TUNE- (DOWN) button repeatedly to set the minute value. Press and hold the buttons to speed up the forward or reverse scanning of the digits.
6. Press the MODE button again to finish clock setting.  
**Note:** If the unit was reset or if you are charging a completely dead battery, you need to set the clock again.

## LISTENING TO THE RADIO

1. Press the  button to turn on the unit, LCD backlight turns on.
2. Tap the MODE button to select AM/FM/Weather band in below sequence. The radio indicator displays.

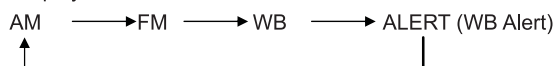

3. To manually tune to a desired station, repeatedly tap the TUNE+ / - button.
4. To automatically search for stations with strong signals, press and hold the TUNE+ / - button until the frequency digits on display begins to scan then release the button. The tuner will stop on the first strong signal it finds.
5. Press VOLUME + / - button to obtain the desired sound level.
6. Press the  button on main unit to turn unit into standby mode after listening. The LCD backlight will automatically turn off after 15 seconds.

### Notes:

- Manual tune to select weaker stations that might be skipped during automatic tuning.
- If the automatic tuning does not stop on the exact frequency of the station, for example, it stops on 88.9 MHz instead of 88.8 MHz, use the manual tuning method to "fine tune" to the exact frequency of the desired station.
- In power on mode, the LCD backlight will automatically turn off for power saving if no



buttons are pressed within a 20 seconds.

### HINTS FOR BEST RECEPTION:

- The AM antenna is located inside the cabinet of the unit. If AM reception is weak, change the position of unit until the internal antenna picks up the strongest signal.
- To insure maximum FM tuner reception, the Telescopic Antenna should be fully extended and rotated to obtain the best possible station reception.

## LISTENING TO A WEATHER CHANNEL

### 1) Weather Band

1. Press the  button to turn on the unit.
2. Tap the MODE button to select weather band until "WB" icon appears steadily on display.
3. Tap the TUNE + / - button to select your local weather broadcasting.
4. Press the VOLUME +/- button to obtain the desired sound level.
5. To turn the radio off, press the  button.

Weather Band Channel Frequency Table

CHANNEL	FREQUENCY(MHz)
CH1	162.400
CH2	162.425
CH3	162.450
CH4	162.475
CH5	162.500
CH6	162.525
CH7	162.550

**Note:** With regard to the NOAA Weather Band: You need to identify which band receives your local weather band report. When you change locations either to another city or state, you may need to choose a different band to get the local report in that location.

### HINTS FOR BEST RECEPTION:

- To insure maximum weather band reception, the Telescopic Antenna should be fully extended and rotated to obtain the best possible station reception.

### 2) RECEIVING AN EMERGENCY WEATHER ALERT

The Weather Alert function allows you to set the weather radio to a standby mode that will turn the radio on automatically if there is a severe weather emergency in your area. To receive emergency weather alert warnings, turn the unit on, tune to the strongest local NOAA weather channel, adjust the volume to a level that you will hear when an alert is received. The radio remains silent until an "alert" broadcast occurs.

1. Tap the MODE button to select weather band until "WB" appears on display steadily.
2. Tap the TUNE + / - button to select your local weather station.

3. Tap the MODE button again to enter Weather Alert standby mode, "ALERT" appears on the display. Unit will go on automatically when there is an alert from the National Weather Service.

4. Tap the MODE button to turn off the NOAA Alert by switch it to other mode. It is recommended to use the AC adaptor to power the radio when you turn on the NOAA Alert.

**Note:** 1.) The radio will continue to drain the battery if it's left in Weather Standby Mode, so it is highly recommended that you use a USB power adaptor (not included) to prevent the battery from completely draining and turning the radio off while in use. See the "USB POWER" section above for more information on the USB charger.

2.) NOAA Weather band is a service broadcast of the U.S. Government and available in all 50 states, Puerto Rico and the U.S. Virgin Islands.

3.) The NOAA Weather Service broadcasts a test alert every Wednesday between 11 am and Noon. To receive the broadcasts, the radio must be within the range of the local broadcast site, 10 - 40 miles, depending on terrain and obstructions.

#### To learn more:

Click on <http://www.nws.noaa.gov/nwr/> for NOAA (National Oceanic & Atmospheric Administration) and <http://www.ec.gc.ca/> for Environment Canada.

### CHARGING THE INTERNAL BATTERY

**NOTE:** Make sure the clear insulator tab is removed from the battery compartment to activate the internal rechargeable battery.

#### DYNAMO CHARGING

1. Set the Battery Selector Switch on the front panel to the "LI-ION"  position.
2. When you turn the hand crank, the built-in dynamo will start to generate electricity. The unit will charge the Lithium battery automatically as long as you turn the hand crank.
3. While charging, the CHARGE LED on the front panel of the unit will light up red.

**NOTE:** While the intensity of the battery power is limited, when the low battery indicator on LCD display is flashing, the internal rechargeable Lithium battery is low and needs to be charged. Rotate the Hand Crank again to begin charging the internal battery.

#### COMPUTER USB CHARGING

1. Set the Battery Selector Switch on the front panel to the "LI-ION"  position.
2. Use a standard USB to micro USB cable (not included), plug one end with USB into the computer USB port. Plug the other end with micro USB into micro USB jack of the unit. It will start to charge the Lithium battery automatically when your computer is ON.
3. While charging, the CHARGE LED on front panel of the unit will light up red. It will turn to green when the battery is fully charged.

**NOTE:** 1.) We recommend you charge the Lithium battery for 5 - 6 hours prior to use.

Please do not charge the battery longer than recommendation as it will shorten the battery life.

2.) The radio should not be used while charging with your computer.

#### SOLAR CHARGING

The solar panel is located on the top of the unit. Reposition the unit so the top panel is facing towards the sun for optimal charging if necessary.

1. Set the Battery Selector Switch on the front panel to the "LI-ION"  position.
2. Put the unit in direct sunlight and the unit will begin charging the internal rechargeable battery automatically.
3. While charging, the CHARGE LED on the front panel of the unit will light up red.

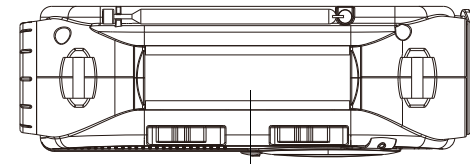



Solar Panel

**NOTE:** The unit can only be charged using outdoor sunlight. Indoor incandescent lights and lamps are not strong enough to charge the rechargeable battery properly.

### CHARGING YOUR SMART PHONE OR PORTABLE DEVICE

This unit features a USB port for charging your portable device (iPod, iPhone, Android phone, etc.)

When used with the USB charging cord that came with your device.

1. Fully charge the built-in rechargeable lithium battery prior to attaching the device to be charged.
2. Set the Battery Selector Switch on the front panel to the "LI-ION"  position.  
**Note:** You cannot charge your portable device with the Battery Selector Switch in the "AA Battery"  position, the "PHONE" message will not appear on the screen.
3. Plug one end of the USB cable (not included) into the USB port located on the back of the JEP-650. Plug the other end of the cord into the device you wish to charge.
4. Press and hold the  button for 2 seconds until "PHONE" message appears on display.
5. Observe the battery charge indicator on your device and the charging will start immediately.
6. It is recommended that you fully charge the internal Li-ion battery prior to attempting to charge a mobile device with the USB port. The USB port is only capable of delivering the amount of power that is left in the internal Li-ion battery.
7. Unplug the cable when your device is charged or when the internal Li-ion battery of the JEP-650 is drained.

8. Press the POWER button to exit smartphone charging mode, the "PHONE" message will disappear from JEP-650 display.

#### **CAUTION:**

Before charging, please refer to the user manual of the device you wish to charge to make sure the charging current required does not exceed 1Amp (1,000 mA) of charging current. Overloading the charge circuit may damage the JEP-650 and void the warranty.

#### **NOTE:**

- 1.) Some smart phones and portable devices use proprietary USB connections and circuitry, so they may not charge when plugged into the USB port. Please refer to your device user manual before you attempt to charge them.
- 2.) It is normal for the JEP-650 to be warm while the USB port is in use and charging your smart phone or portable device.
- 3.) The unit will switch to from charging mode to standby mode automatically if internal Li-ion battery is drained.
- 4.) After removing the external device you attached to JEP-650 for charging, wait for 10 – 15 seconds before powering on the unit.
- 5.) In some cases, the internal battery may not fully charge your portable device. It's recommended that if you start to get intermittent charge indications, unplug the device and fully recharge the internal battery of the JEP-650 before attempting to charge your portable device again. See the "Charging the Internal Battery" section above for more information.

### **CHARGE/NOAA ALERT LED INDICATOR**

#### **Battery Charge LED**

##### Battery Charging via USB

- LED lights Red during charging.
- LED lights Green when fully charged.

##### Battery Charging via Crank

- LED lights Red during charging.

##### Battery Charging via Solar

- LED lights Red during charging (Must be outdoors and under strong/direct sunlight)

#### **Weather Alert LED**

##### NOAA Alert mode

- LED flashes when a weather alert signal is detected.

### **USING THE FLASHLIGHT**

A LED flashlight is built into the side of the unit.

1. To use the flashlight, set the LIGHT switch to ON position.
2. When the flashlight is on, turn on the Siren alarm, flashlight will change from solid on mode to flashing mode.
3. Set the LIGHT switch to OFF position to turn it off.

**NOTE:** When the flashlight is used for extended periods of time and causes the battery to drain, the flashlight may no longer work even though the display still shows the time.

### **USING THE SIREN**

A Siren alarm is built into the side of the unit.

1. Set the SIREN switch to ON position, alarm will sound.
2. Set the SIREN switch to OFF position, alarm will off.

**Note:** 1.) When the flashlight is on, turn on the Siren alarm, flashlight will change to flash from solid on.  
2.) The Power ON/OFF button will be disabled when the Siren switch is in the ON position.

### **USE EARBUDS (NOT INCLUDED)**

Inserting the plug of your earbuds into the earbuds jack will enable you to listen in private. When using earbuds, the speakers will be disconnected.

#### **Read this Important Information before Using Your Earbuds**

- 1.) Avoid extended play at very high volume as it may impair your hearing.
- 2.) If you experience ringing in your ears, reduce the volume or shut off the unit.
- 3.) Keep the volume at a reasonable level even if your headset is an open-air type designed to allow you to hear outside sounds. Please note that excessively high volume may still block outside sounds.

### **USING THE CARRYING STRAP/STORAGE COMPARTMENT**

Install the carrying strap into the strap mounting holes on the top of the unit.

If you don't plan on installing the strap, it can be folded and stored in the storage compartment.

### **CARE AND MAINTENANCE**

1. Do not subject the unit to excessive force, shock, dust or extreme temperature.
2. Do not tamper the internal components of the unit.
3. Clean your unit with a damp (never wet) cloth. Solvent or detergent should never be used.
4. Avoid leaving your unit in direct sunlight or in hot, humid or dusty places.
5. Keep your unit away from heating appliances and sources of electrical noise such as fluorescent lamps or motors.

**CAUTION:** Never allow any water or other liquids to get inside the unit while cleaning.

#### **Resetting the Unit**

If the unit experiences a power surge or electric shock, it is possible that the internal micro-controller may lock up and the unit will not respond to any commands from the panel controls. In this event, use a straightened paper clip, toothpick or similar objects to press the RESET button located on the back of the unit (see the below figure). The reset operation clears the system memory and all of your previous settings will be erased.

**CAUTION:** DO NOT USE A SHARP OR POINTED OBJECT TO PRESS THE RESET BUTTON. IT MAY DAMAGE THE RESET SWITCH INSIDE THE UNIT.



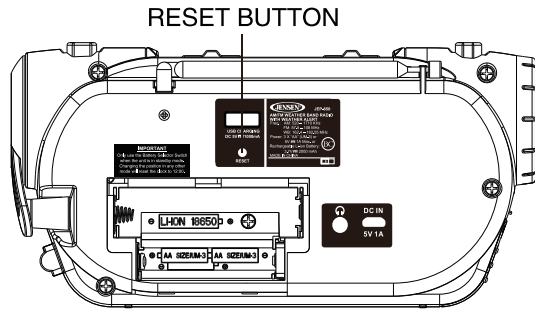

### TROUBLESHOOTING GUIDE

If you experience difficulties in the use of this music system please check the following or call 1-800-777-5331 for Customer Service.

Symptom	Possible Cause	Solution
No/low sound when power on the radio	VOLUME control is set to minimum.	Adjust the VOLUME control.
	Station has not been tuned properly.	Tune the station properly.
	FM reception is weak.	Extend and rotate the telescopic antenna.
	AM reception is weak.	Relocate the position of the unit.
	Unit in Weather Alert Mode	Select AM, FM or WB mode as desired.
Power is not on	The built-in rechargeable battery is low and the "AA" batteries are exhausted.	Recharge the built-in rechargeable battery and replace all 3 "AA" batteries with fresh ones.
	Unit is charging your portable device	Wait charging finish or unplug your portable device from the unit, wait for 10 – 15 seconds and then turns the power on.
USB no charging	The built-in rechargeable battery is low.	Fully recharge the built-in rechargeable battery before charging your Potable device.

### SPECIFICATION

#### Power requirement:

DC Input: 3 X AA (UM-3) Batteries or  
Built-in DC 3.7V, 2000mAh Li-ion rechargeable battery or  
USB Power: DC 5V, 1000mA (Max.)

#### Frequency Range

Radio Band FM 87.5 ~ 108 MHz  
AM 520 - 1710 KHz  
WX CH1 – 7



At Spectra, environmental and social responsibility is a core value of our business. We are dedicated to continuous implementation of responsible initiatives with an aim to conserve and maintain the environment through responsible recycling.

Please visit us at <http://www.spectraintl.com/green.htm> for more information on Spectra's green initiatives or to find a recycler in your area.

### 90 DAY LIMITED WARRANTY AND SERVICE VALID IN THE U.S.A. ONLY

SPECTRA MERCHANDISING INTERNATIONAL, INC. warrants this unit to be free from defective materials or factory workmanship for a period of 90 days from the date of original customer purchase and provided the product is utilized within the U.S.A. This warranty is not assignable or transferable. Our obligation under this warranty is the repair or replacement of the defective unit or any part thereof, except batteries, when it is returned to the SPECTRA Service Department, accompanied by proof of the date of original consumer purchase, such as a duplicate copy of a sales receipt.

You must pay all shipping charges required to ship the product to SPECTRA for warranty service. If the product is repaired or replaced under warranty, the return charges will be at SPECTRA's expense. There are no other express warranties other than those stated herein.

This warranty is valid only in accordance with the conditions set forth below:

1. The warranty applies to the SPECTRA product only while:
  - a. It remains in the possession of the original purchaser and proof of purchase is demonstrated.
  - b. It has not been subjected to accident, misuse, abuse, improper service, usage outside the descriptions and warnings covered within the user manual or non-SPECTRA approved modifications.
  - c. Claims are made within the warranty period.
2. This warranty does not cover damage or equipment failure caused by electrical wiring not in compliance with electrical codes or SPECTRA user manual specifications, or failure to provide reasonable care and necessary maintenance as outlined in the user manual.
3. Warranty of all SPECTRA products applies to residential use only and is void when products are used in a nonresidential environment or installed outside the United States.

This warranty gives you specific legal rights, and you may also have other rights which vary from state to state. TO OBTAIN SERVICE please remove all batteries (if any) and pack the unit carefully and send it freight prepaid to SPECTRA at the address shown below. IF THE UNIT IS RETURNED WITHIN THE WARRANTY PERIOD shown above, please include a proof of purchase (dated cash register receipt) so that we may establish your eligibility for warranty service and repair of the unit without cost. Also include a note with a description explaining how the unit is defective. A customer service representative may need to contact you regarding the status of your repair, so please include your name, address, phone number and email address to expedite the process.

IF THE UNIT IS OUTSIDE THE WARRANTY PERIOD, please include a check for **\$20.00** to cover the cost of repair, handling and return postage. All out of warranty returns must be sent prepaid.

It is recommended that you contact SPECTRA first at 1-800-777-5331 or by email at [custserv@spectrainfl.com](mailto:custserv@spectrainfl.com) for updated information on the unit requiring service. In some cases the model you have may be discontinued, and SPECTRA reserves the right to offer alternative options for repair or replacement.

SPECTRA MERCHANDISING INTERNATIONAL, INC.  
4230 North Normandy Avenue,  
Chicago, IL 60634, USA.  
1-800-777-5331

To register your product, visit the link on the website below to enter your information.  
<http://www.spectrainfl.com/wform.htm>

1219

Printed in China