



★ ★ ★ ★ ★ ★ **HELLO KITTY** ★ ★ ★ ★ ★ ★
©1976, 2013 SANRIO CO., LTD.

AM/FM DUAL ALARM CLOCK RADIO WITH DIGITAL TUNING



USER MANUAL

KT2051P

THIS IS NOT A TOY !

CAUTION: Electrically Operated Product –
Please use care when plugging AC adapter into AC outlet.

WARNING

TO PREVENT FIRE OR SHOCK HAZARD, DO NOT USE THIS PLUG WITH AN EXTENSION CORD, RECEPTACLE OR OTHER OUTLET UNLESS THE BLADES CAN BE FULLY INSERTED TO PREVENT BLADE EXPOSURE. TO PREVENT FIRE OR SHOCK HAZARD, DO NOT EXPOSE THIS APPLIANCE TO RAIN OR MOISTURE.

WARNING

To reduce the risk of fire or electric shock, do not expose this apparatus to rain or moisture.

IMPORTANT SAFETY INSTRUCTIONS

1. Read these instructions.
2. Keep these instructions.
3. Heed all warnings.
4. Follow all instructions.
5. Do not use this apparatus near water.
6. Cleaning – Unplug this product from the wall outlet before cleaning. Do not use liquid cleaners or aerosol cleaners. Clean only with a dry cloth.
7. Do not block any ventilation openings. Install in accordance with the manufacturer's instructions.
8. Do not install near any heat sources such as radiators, heat registers, stoves, or other apparatus (including amplifiers) that produce heat.
9. Only use attachments/accessories specified by the manufacturer.
10. Use only with a cart, stand, tripod, bracket, or table specified by the manufacturer, or sold with the apparatus. When a cart is used, use caution when moving the cart/ apparatus combination to avoid injury from tip-over.
11. Unplug this apparatus during lightning storms or when unused for long periods of time.
12. Refer all servicing to qualified service personnel. Servicing is required when the apparatus has been damaged in any way, such as AC adapter is damaged, liquid has been spilled or objects have fallen into the apparatus, the apparatus has been exposed to rain or moisture, does not operate normally, or has been dropped.
13. This apparatus shall not be exposed to dripping or splashing water and that no object filled with liquids such as vases shall be placed on the apparatus.
14. The AC adapter is used as disconnect device and it should remain readily operable during intended use. In order to disconnect the apparatus completely, the AC adapter should be disconnected from the main socket outlet completely.
15. Battery shall not be exposed to excessive heat such as sunshine, fire or the like.
16. Danger of explosion if battery is incorrectly replaced. Replace only with the same or equivalent type.



WARNING

This is an alarm clock radio, not a toy! To avoid risk of fire, burns, personal injury and electric shock it should not be played with or placed where small children can reach it.

COMPLIANCE WITH FCC REGULATION

This device complies with Part 15 of the FCC Rules. Operation is subject to the following two conditions:

- (1) this device may not cause harmful interference, and
- (2) this device must accept any interference received, including interference that may cause undesired operation.

Note: This equipment has been tested and found to comply with the limits for a Class B digital device, pursuant to Part 15 of the FCC Rules. These limits are designed to provide reasonable protection against harmful interference in a residential installation. This equipment generates, uses and can radiate radio frequency energy and, if not installed and used in accordance with the instructions, may cause harmful interference to radio communications. However, there is no guarantee that interference will not occur in a particular installation. If this equipment does cause harmful interference to radio or television reception, which can be determined by turning the equipment off and on, the user is encouraged to try to correct the interference by one or more of the following measures:

- Reorient or relocate the receiving antenna.
- Increase the separation between the equipment and receiver.
- Connect the equipment into an outlet on a circuit different from that to which the receiver is connected.
- Consult the dealer or an experienced radio/TV technician for help.

WARNING

Changes or modifications not expressly approved by the party responsible for compliance could void the user's authority to operate the equipment.

PROTECT YOUR FURNITURE!!

To prevent any damage to your furniture we strongly recommend that you purchase small self-adhesive felt pads, available at hardware stores and home improvement centers everywhere, and apply these pads to the bottom of the rubber 'feet' before you place the product on fine wooden furniture.

FUNCTIONS AND CONTROLS

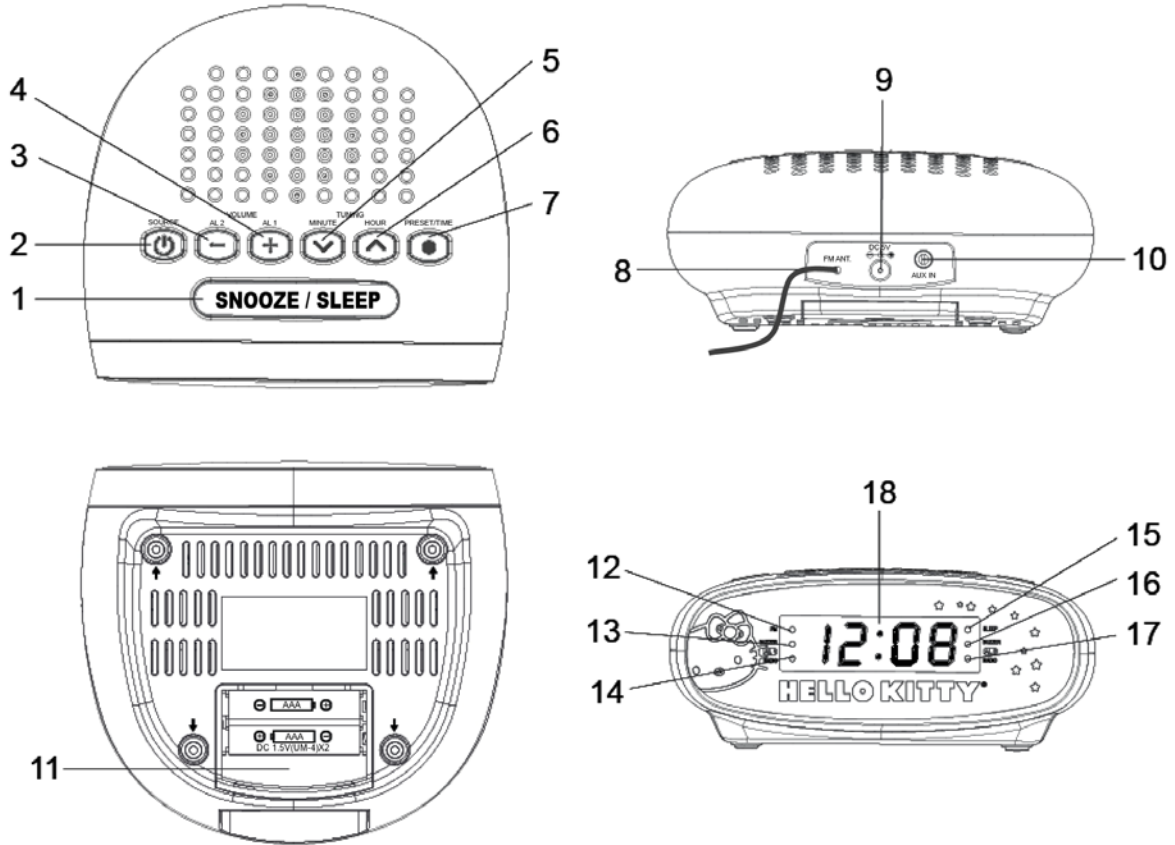

1	SNOOZE / SLEEP	10	AUX IN JACK
2	SOURCE / 	11	BACKUP BATTERY COMPARTMENT (2 X DC 1.5V "AAA" BATTERIES)
3	VOLUME - / ALARM 2 (AL 2)	12	PM INDICATOR
4	VOLUME + / ALARM 1 (AL 1)	13	BUZZER ALARM 1 INDICATOR
5	MINUTE / TUNE -	14	RADIO ALARM 1 INDICATOR
6	HOUR / TUNE +	15	SLEEP INDICATOR
7	PRESET / TIME	16	BUZZER ALARM 2 INDICATOR
8	FM WIRE ANTENNA	17	RADIO ALARM 2 INDICATOR
9	DC JACK (DC5V)	18	LED CLOCK & AM/FM FREQUENCY DISPLAY

OPERATING INSTRUCTIONS

POWER REQUIREMENTS

This unit operates on a 120V AC adapter. Plug the AC adapter (included) into a household outlet AC source. This unit is equipped with a battery back-up system, requiring two DC 1.5V “AAA” type batteries (not included). Insert the battery in the **BATTERY COMPARTMENT**, making certain that the positive and negative (+ and -) sides are properly aligned.

CONNECTING THE AC ADAPTER

1. After correctly installing the backup batteries, insert the DC plug of the AC adapter (included) into the DC Jack of the unit.
2. Fully insert the blades of the AC adapter (included) into the slots of a working wall socket as shown.
3. The **LED DISPLAY** of the unit will show a flashing time of “12:00” prompting you that the time is not valid and needs to be adjusted to the right time as soon as possible.
4. After correctly setting up the time (as described in the next section), your unit is now in standby mode.

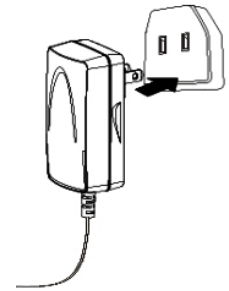

Note: If power failure occurs, the clock automatically switches to the battery power supply, the clock and alarm time memory continues running internally and the radio presets are preserved. When power returns, the unit switches back to AC adapter again. The display will not exhibit time during power failure but the clock will keep correct time internally.

Notes on Battery Care:

- ◆ Use only the size and type of batteries specified.
- ◆ If the unit is not to be used for an extended period of time, remove the batteries.
- ◆ Old or leaking batteries can cause damage to the unit and may void the warranty.
- ◆ Do not try to recharge batteries not intended to be recharged; they can overheat and rupture (Follow battery manufacturer’s directions).
- ◆ Do not dispose of batteries in fire, batteries may leak or explode.

SETTING THE LED DIGITAL CLOCK

1. In standby mode, press and hold the **TIME** button. The time digits will blink. .
2. Press the **HOUR** button to set the current hour. Press and hold the button to scroll faster.
3. Press the **MINUTE** button to set the current minute. Press and hold the button to scroll faster.
4. Press **TIME** button again and confirm the current time is set.

Notes:

- ◆ The PM indicator will light when the hour is set in the PM time period.
- ◆ You can adjust the time any time when the unit is in standby mode.

SETTING ALARMS

In standby mode, tap the **ALARM 1** or **ALARM 2** button once to check the alarm time and wake up option (Buzzer, Radio, Alarm off).

1. Press and hold the **ALARM 1** or **ALARM 2** button for 2 seconds when the alarm time is showing. The time digits will blink for 4 seconds to allow you to adjust the alarm time.
2. Tap the **HOUR** button to adjust the hour. Press and hold the button to scroll faster.
3. Tap the **MINUTE** button to adjust the minute. Press and hold the button to scroll faster.
4. Press **ALARM 1** or **ALARM 2** button to confirm the alarm time setting.

Wake to Buzzer (or Radio)

5. Press **ALARM 1** or **ALARM 2** button repeatedly to select to wake up to Buzzer (or Radio). The respective **BUZZER** (or **RADIO**) **ALARM INDICATOR** for **ALARM 1** or **ALARM 2** will flash for 4 seconds and then become steady indicating that the wake up mode has been correctly set. If there is no indicator, it means the **ALARM 1** or **ALARM 2** is disabled.
6. The Buzzer (or Radio) will automatically turn on when the alarm time is reached. The Buzzer (or Radio) indicator of **ALARM 1** or **ALARM 2** will flash.
7. The Buzzer (or Radio) sounds for 60 minutes and then turn off automatically if the snooze button is not pressed.
8. To stop the Buzzer (or Radio) sound immediately, tap the  button to turn off.

Notes:

- ◆ You should tune to your desired radio station first before starting to set the alarm time and selecting wake up mode.
- ◆ Alarm will ring again at the same time each day unless disabled.
- ◆ To stop alarm from automatically sounding on the following days, press repeatedly **ALARM 1** button or **ALARM 2** button in standby mode. The **ALARM 1 / 2 INDICATOR** will turn off and alarm 1 / 2 will be disabled.
- ◆ To resume alarm 1 / 2, press **ALARM 1** button or **ALARM 2** button in standby mode again.

SNOOZE FUNCTION

When the alarm rings, press **SNOOZE** button to suspend the alarm and activate the snooze function. Alarm will stop and ring again 9 minutes later. If you press **SNOOZE** button again, the alarm will stop momentarily and ring again in 9 minutes and so on.

Notes:



- ◆ The snooze interval time is fixed at 9 minutes.
- ◆ To turn the snooze function OFF, press the **SOURCE** button.

SLEEP FUNCTION

When listening to radio, press **SLEEP** button to enter sleep mode. You can just adjust the sleep timer from 10 to 90 minutes by pressing the **SLEEP** button. The unit automatically turns off after the selected amount of time expires.

LISTENING TO THE RADIO

Notes:

- ◆ Ensure that the FM wire antenna is completely tangle free and extended to have the best FM reception.
 - ◆ The AM band uses an internal, directional antenna. Rotate the entire radio for best AM reception.
1. Press the  button to turn the radio ON.
 2. Press the **SOURCE** button again to select AM or FM band. When AM band is selected, the AM frequency will show on LED display.
 3. Use the **TUNE +** or **TUNE –** button to select the desired radio station. If you press and hold the **TUNE +** or **TUNE –** button for one second, then release, the unit will automatically scan to the next broadcasting station.
 4. The broadcasting radio frequency will be displayed for about 4 seconds before reverting to the clock time.
 5. Press and hold the  button for about 2 seconds to turn the radio OFF.

TO SET/RECALL RADIO PRESETS

1. Press the  button to turn the radio ON.
2. Press the **SOURCE** button again to select AM or FM band. When FM band is selected, the FM frequency will show on the LED display.
3. Use the **TUNE +** or **TUNE –** button to select the desired radio station.
4. Press and hold the **PRESET** button to enable the program function. The preset channel number “P01” indicator will flash on the LED display for initial setup. Otherwise, the next available preset memory number will then flash in the LED display. You may change to another preset memory number by tapping the **TUNE +** or **TUNE –** button.
Note: If you select an existing preset memory, the new radio station frequency will replace the existing one.
5. Repeat above steps #3 thru #4 to preset up to 10 stations for each of the AM and FM bands.
6. To retrieve one of the preset stations already programmed, press **PRESET** button repeatedly until you reach the desired preset number (radio station).

AUXILIARY INPUT

This unit provides an auxiliary audio signal input jack for connecting external audio devices like MP3 players and CD players and to listen to them through the speakers of this unit.

1. Use an audio cable (not included) with one 3.5 mm stereo plug on each end.
2. Plug one end into the **AUX-IN Jack** on the main unit and the other end of the cable into the Line-out Jack or Headphone Jack of your external audio device.
3. Turn on the unit AND external audio device.
4. To select the auxiliary audio input, tap the **SOURCE** button repeatedly to select AUX mode. “AU” appears on the **LED DISPLAY**.
5. The volume level can now be controlled through the main unit. Operate all other functions from the external audio device itself.
6. Press and hold the  button for about 2 seconds to turn the unit OFF.

Notes:

- ◆ If you connect this unit to the Line-Out Jack of your external device, then you only need to adjust the volume control of this unit. If you connect this unit to the Headphone Jack of your external device, you may need to adjust both the volume control of your external device and the volume control of this unit to find the most desirable volume setting.
- ◆ Remember to turn the power of the external audio device OFF after use.

RESETTING YOUR CLOCK RADIO

If the unit does not respond or exhibits erratic or intermittent operation, you may have experienced an electrostatic discharge (ESD) or a power surge that triggered the internal microcontroller to shut down automatically. If this occurs, simply disconnect the AC adapter and remove the system back-up batteries, wait for at least 3 minutes and then setup the unit as if you were using it for the very first time.

CARE AND MAINTENANCE

1. Clean the unit with a soft, damp (never wet) cloth. Solvent or detergent should never be used.
2. Avoid operating your unit under direct sunlight or in hot, humid or dusty places to reduce the risk of fire or electric shock.
3. Keep your unit away from heating appliances and sources of electrical noise such as fluorescent lamps or motors.
4. For better clock display clarity, avoid operating the unit under direct sunlight or in strong room illumination.
5. Unplug the AC adapter from the unit and the electrical power outlet immediately in case of malfunction.

SPECIFICATIONS

AC Adapter:	AC input	120V~ 60Hz
	DC Output	5V= 200mA
Battery Back-up:	2 x DC 1.5V AAA (UM-4) type batteries	
Frequency Range:	FM 87.5 - 108 MHz; AM 520 -1710 kHz	

90 DAY LIMITED WARRANTY AND SERVICE VALID IN THE U.S.A. ONLY

SPECTRA MERCHANDISING INTERNATIONAL, INC. warrants this unit to be free from defective materials or factory workmanship for a period of 90 days from the date of original customer purchase and provided the product is utilized within the U.S.A. This warranty is not assignable or transferable. Our obligation under this warranty is the repair or replacement of the defective unit or any part thereof, except batteries, when it is returned to the SPECTRA Service Department, accompanied by proof of the date of original consumer purchase, such as a duplicate copy of a sales receipt.

You must pay all shipping charges required to ship the product to SPECTRA for warranty service. If the product is repaired or replaced under warranty, the return charges will be at SPECTRA's expense. There are no other express warranties other than those stated herein.

This warranty is valid only in accordance with the conditions set forth below:

1. The warranty applies to the SPECTRA product only while:
 - a. It remains in the possession of the original purchaser and proof of purchase is demonstrated.
 - b. It has not been subjected to accident, misuse, abuse, improper service, usage outside the descriptions and warnings covered within the user manual or non-SPECTRA approved modifications.
 - c. Claims are made within the warranty period.
2. This warranty does not cover damage or equipment failure caused by electrical wiring not in compliance with electrical codes or SPECTRA user manual specifications, or failure to provide reasonable care and necessary maintenance as outlined in the user manual.
3. Warranty of all SPECTRA products applies to residential use only and is void when products are used in a nonresidential environment or installed outside the United States.

This warranty gives you specific legal rights, and you may also have other rights which vary from state to state. TO OBTAIN SERVICE please remove all batteries (if any) and pack the unit carefully and send it freight prepaid to SPECTRA at the address shown below. IF THE UNIT IS RETURNED WITHIN THE WARRANTY PERIOD shown above, please include a proof of purchase (dated cash register receipt) so that we may establish your eligibility for warranty service and repair of the unit without cost. Also include a note with a description explaining how the unit is defective. A customer service representative may need to contact you regarding the status of your repair, so please include your name, address, phone number and email address to expedite the process.

IF THE UNIT IS OUTSIDE THE WARRANTY PERIOD, please include a check for **\$8.00** to cover the cost of repair, handling and return postage. All out of warranty returns must be sent prepaid.

It is recommended that you contact SPECTRA first at 1-800-777-5331 or by email at custserv@spectraintl.com for updated information on the unit requiring service. In some cases the model you have may be discontinued, and SPECTRA reserves the right to offer alternative options for repair or replacement.

SPECTRA MERCHANDISING INTERNATIONAL, INC.
4230 North Normandy Avenue,
Chicago, IL 60634, USA.
1-800-777-5331

To register your product, visit the link below
to enter your information.
<http://www.spectraintl.com/wform.htm>

Licensed by:
Marino Andriani, LLC
Distributed by:
Spectra Merchandising International, Inc.
Chicago, IL 60634
www.spectraintl.com



HELLO KITTY[®]
by **Sanrio**[®]

©1976, 2013 SANRIO CO., LTD.
Used Under License.
www.sanrio.com



SIL- 34037

0713

Printed in China